

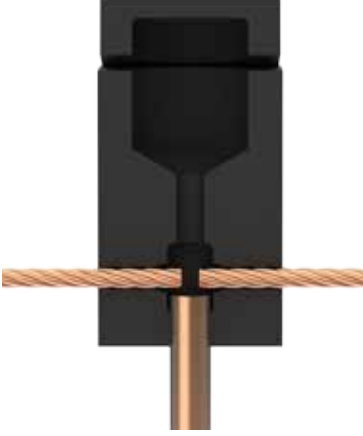

Termokaynak Sistemleri
Exothermic Welding Systems



Termokaynak uygulaması aşağıda belirtilen şekilde yapılmaktadır.
Thermowelding must be done according to the following:



İletkenler kalıbın içine yerleştirilir. Uygun pense yardımı ile kalıp kapatılır ve kalıbın ek yerlerinin tamamen kapandığından emin olunur.

Conductors are placed in the mould. The mould is closed with a suitable handle clamp making sure the seams are tightly closed.

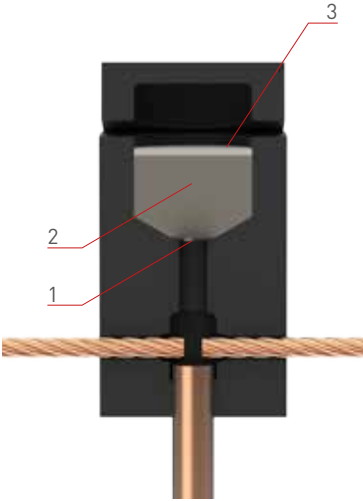

**Kalıp haznesine metal disk (1) yerleştirilir.
İletken kaynağına uygun miktarda toz (2) metal diskin üzerine boşaltılır.
Tozun üzerine başlama tozu (3) dökülür, ve kıvılcım tabancası ile ateşlenir.**

Metal disk (1) is inserted to the mold. Sufficient welding powder (2) is poured in the mould over the metal disk. Lastly, Igniting powder (3) is poured on top and ignited with flint gun.

Termokaynak uygulaması aşağıda belirtilen şekilde yapılmaktadır.
Thermowelding must be done according to the following:

Erimiş bakır alaşımı, metal diski eritir ve kaynağın gerçekleşeceği hazneye akar.
Tepkime kalıbın içinde güvenli biçimde gerçekleşir.

Molten copper compound will melt the metal disk and flow into the weld container. Reaction takes place safely inside the container.

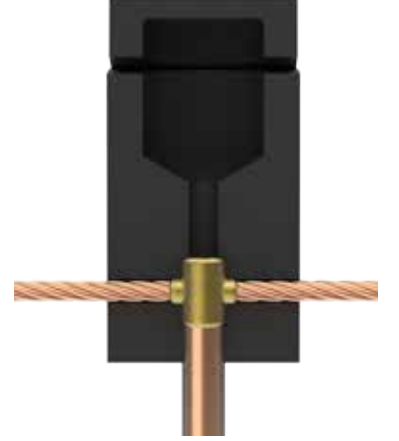

Erimiş bakır alaşımının soğuması beklenir. Termokaynak işlemi tamamlandıktan sonra kalıp içi, bir sonraki kullanım için temizlik fırçası ile temizlenir.

After the molten copper compound cools off and the thermo welding is complete, the mould is cleaned with the brush for the next use.

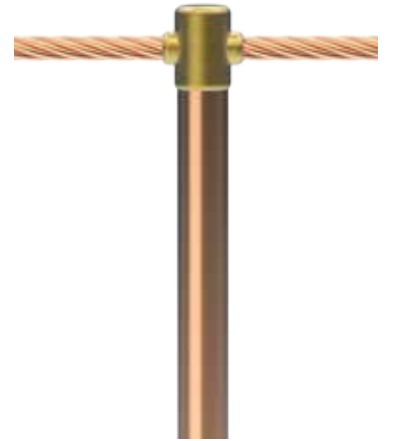

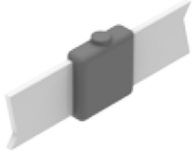
Bağlantı Seçenekleri
Connection Selector**Baradan Baraya / Bar to Bar**

Sayfa / Page.....128

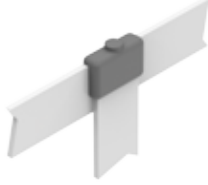

Sayfa / Page.....128



Sayfa / Page.....129

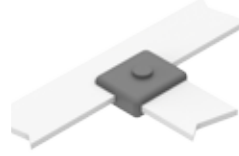

Sayfa / Page.....129



Sayfa / Page.....130

Baradan Topraklama Elektroduna / Bar to Earth Rod

Sayfa / Page.....131



Sayfa / Page.....132

Baradan Çelik Yüzeğe / Bar to Steel Surface

Sayfa / Page.....133



Sayfa / Page.....133

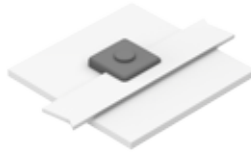

Sayfa / Page.....134

Kablodan Baraya / Cable to Bar

Sayfa / Page.....135

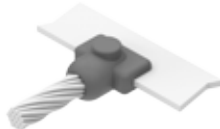

Sayfa / Page.....136



Sayfa / Page.....137

Bağlantı Seçenekleri Connection Selector

Kablodan Kabloya / Cable to Cable



Sayfa / Page.....138



Sayfa / Page.....139



Sayfa / Page.....140

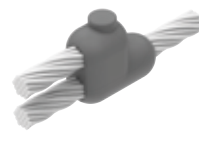

Sayfa / Page.....141



Sayfa / Page.....142



Sayfa / Page.....143



Sayfa / Page.....144

Kablodan Topraklama Elektroduna / Cable to Earth Rod



Sayfa / Page.....145



Sayfa / Page.....146



Sayfa / Page.....147



Sayfa / Page.....148



Sayfa / Page.....149



Sayfa / Page.....150

Kablodan İnşaat Demirine / Cable to Reinforcing Bar



Sayfa / Page.....151

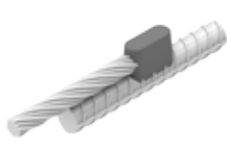

Sayfa / Page.....152



Sayfa / Page.....152



Sayfa / Page.....153



Sayfa / Page.....153

Kablodan Çelik Yüze / Cable to Steel Surface



Sayfa / Page.....154



Sayfa / Page.....154



Sayfa / Page.....155

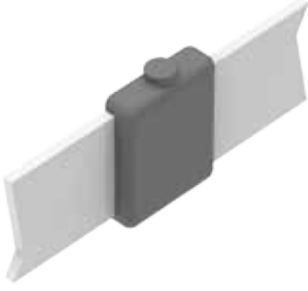

Sayfa / Page.....155

Baradan Baraya
 Bar to Bar

İletken Ölçüsü	Kaynak Tozu (gr)	Pota	Pense Modeli
Conductor Diameter	Welding Powder (gr)	Mould	Handle Clamp
20x3 mm	45	ET.00.TKPC.BB1.203	ET.00.TPP
25x2 mm	65	ET.00.TKPC.BB1.252	ET.00.TPP
25x3 mm	65	ET.00.TKPC.BB1.253	ET.00.TPP
25x4 mm	90	ET.00.TKPC.BB1.254	ET.00.TPP
30x2 mm	65	ET.00.TKPC.BB1.302	ET.00.TPP
30x3 mm	65	ET.00.TKPC.BB1.303	ET.00.TPP
30x4 mm	90	ET.00.TKPC.BB1.304	ET.00.TPP
30x5 mm	115	ET.00.TKPC.BB1.305	ET.00.TPP
40x3 mm	90	ET.00.TKPC.BB1.403	ET.00.TPP
40x4 mm	115	ET.00.TKPC.BB1.404	ET.00.TPP
40x5 mm	150	ET.00.TKPC.BB1.405	ET.00.TPP
40x6 mm	200	ET.00.TKPC.BB1.406	ET.00.TPP
50x3 mm	150	ET.00.TKPD.BB1.503	ET.00.TPP
50x4 mm	200	ET.00.TKPD.BB1.504	ET.00.TPP
50x5 mm	200	ET.00.TKPD.BB1.505	ET.00.TPP
50x6 mm	250	ET.00.TKPD.BB1.506	ET.00.TPP

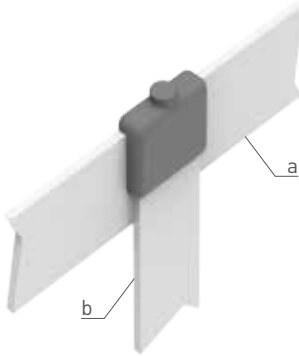
Baradan Baraya
 Bar to Bar

İletken Ölçüsü (a)	İletken Ölçüsü (b)	Kaynak Tozu (gr)	Pota	Pense Modeli
Conductor Diameter (a)	Conductor Diameter (b)	Welding Powder (gr)	Mould	Handle Clamp
20x3 mm	20x3 mm	45	ET.00.TKPC.BB3.203	ET.00.TPP
25x2 mm	25x2 mm	65	ET.00.TKPC.BB3.252	ET.00.TPP
25x3 mm	25x3 mm	65	ET.00.TKPC.BB3.253	ET.00.TPP
25x4 mm	25x4 mm	90	ET.00.TKPC.BB3.254	ET.00.TPP
30x2 mm	30x2 mm	65	ET.00.TKPC.BB3.302	ET.00.TPP
30x3 mm	30x3 mm	90	ET.00.TKPC.BB3.303	ET.00.TPP
30x4 mm	30x4 mm	115	ET.00.TKPC.BB3.304	ET.00.TPP
30x5 mm	30x5 mm	115	ET.00.TKPC.BB3.305	ET.00.TPP
40x3 mm	40x3 mm	115	ET.00.TKPC.BB3.403	ET.00.TPP
40x4 mm	40x4 mm	150	ET.00.TKPC.BB3.404	ET.00.TPP
40x5 mm	40x5 mm	150	ET.00.TKPC.BB3.405	ET.00.TPP
40x6 mm	40x6 mm	200	ET.00.TKPC.BB3.406	ET.00.TPP
50x3 mm	50x3 mm	200	ET.00.TKPD.BB3.503	ET.00.TPP
50x4 mm	50x4 mm	200	ET.00.TKPD.BB3.504	ET.00.TPP
50x5 mm	50x5 mm	200	ET.00.TKPD.BB3.505	ET.00.TPP
50x6 mm	50x6 mm	250	ET.00.TKPD.BB3.506	ET.00.TPP

Baradan Baraya

Bar to Bar

İletken Ölçüsü	Kaynak Tozu (gr)	Pota	Pense Modeli
Conductor Diameter	Welding Powder (gr)	Mould	Handle Clamp
20x3 mm	45	ET.00.TKPC.BB7.203	ET.00.TPP
25x2 mm	65	ET.00.TKPC.BB7.252	ET.00.TPP
25x3 mm	65	ET.00.TKPC.BB7.253	ET.00.TPP
25x4 mm	90	ET.00.TKPC.BB7.254	ET.00.TPP
30x2 mm	65	ET.00.TKPC.BB7.302	ET.00.TPP
30x3 mm	65	ET.00.TKPC.BB7.303	ET.00.TPP
30x4 mm	90	ET.00.TKPC.BB7.304	ET.00.TPP
30x5 mm	115	ET.00.TKPC.BB7.305	ET.00.TPP
40x3 mm	90	ET.00.TKPC.BB7.403	ET.00.TPP
40x4 mm	115	ET.00.TKPC.BB7.404	ET.00.TPP
40x5 mm	150	ET.00.TKPC.BB7.405	ET.00.TPP
40x6 mm	200	ET.00.TKPC.BB7.406	ET.00.TPP
50x3 mm	150	ET.00.TKPD.BB7.503	ET.00.TPP
50x4 mm	200	ET.00.TKPD.BB7.504	ET.00.TPP
50x5 mm	200	ET.00.TKPD.BB7.505	ET.00.TPP
50x6 mm	250	ET.00.TKPD.BB7.506	ET.00.TPP

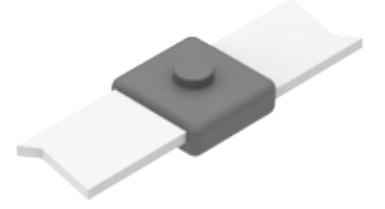

Baradan Baraya

Bar to Bar

İletken Ölçüsü (a)	İletken Ölçüsü (b)	Kaynak Tozu (gr)	Pota	Pense Modeli
Conductor Diameter (a)	Conductor Diameter (b)	Welding Powder (gr)	Mould	Handle Clamp
20x3 mm	20x3 mm	45	ET.00.TKPC.BB14.203	ET.00.TPP
25x2 mm	25x2 mm	65	ET.00.TKPC.BB14.252	ET.00.TPP
25x3 mm	25x3 mm	65	ET.00.TKPC.BB14.253	ET.00.TPP
25x4 mm	25x4 mm	90	ET.00.TKPC.BB14.254	ET.00.TPP
30x2 mm	30x2 mm	65	ET.00.TKPC.BB14.302	ET.00.TPP
30x3 mm	30x3 mm	90	ET.00.TKPC.BB14.303	ET.00.TPP
30x4 mm	30x4 mm	115	ET.00.TKPC.BB14.304	ET.00.TPP
30x5 mm	30x5 mm	115	ET.00.TKPC.BB14.305	ET.00.TPP
40x3 mm	40x3 mm	115	ET.00.TKPC.BB14.403	ET.00.TPP
40x4 mm	40x4 mm	150	ET.00.TKPC.BB14.404	ET.00.TPP
40x5 mm	40x5 mm	150	ET.00.TKPC.BB14.405	ET.00.TPP
40x6 mm	40x6 mm	200	ET.00.TKPC.BB14.406	ET.00.TPP
50x3 mm	50x3 mm	200	ET.00.TKPD.BB14.503	ET.00.TPP
50x4 mm	50x4 mm	200	ET.00.TKPD.BB14.504	ET.00.TPP
50x5 mm	50x5 mm	200	ET.00.TKPD.BB14.505	ET.00.TPP
50x6 mm	50x6 mm	250	ET.00.TKPD.BB14.506	ET.00.TPP

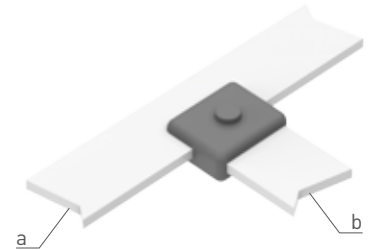

Baradan Baraya

Bar to Bar

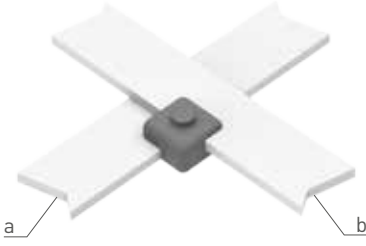

İletken Ölçüsü (a)	İletken Ölçüsü (b)	Kaynak Tozu (gr)	Pota	Pense Modeli
Conductor Diameter (a)	Conductor Diameter (b)	Welding Powder (gr)	Mould	Handle Clamp
20x3 mm	20x3 mm	65	ET.00.TKPC.BB41.203	ET.00.TPP
25x2 mm	25x2 mm	65	ET.00.TKPC.BB41.252	ET.00.TPP
25x3 mm	25x3 mm	65	ET.00.TKPC.BB41.253	ET.00.TPP
25x4 mm	25x4 mm	90	ET.00.TKPC.BB41.254	ET.00.TPP
30x2 mm	30x2 mm	65	ET.00.TKPC.BB41.302	ET.00.TPP
30x3 mm	30x3 mm	115	ET.00.TKPC.BB41.303	ET.00.TPP
30x4 mm	30x4 mm	115	ET.00.TKPC.BB41.304	ET.00.TPP
30x5 mm	30x5 mm	115	ET.00.TKPC.BB41.305	ET.00.TPP
40x3 mm	40x3 mm	200	ET.00.TKPC.BB41.403	ET.00.TPP
40x4 mm	40x4 mm	200	ET.00.TKPC.BB41.404	ET.00.TPP
40x5 mm	40x5 mm	200	ET.00.TKPC.BB41.405	ET.00.TPP
40x6 mm	40x6 mm	200	ET.00.TKPC.BB41.406	ET.00.TPP
50x3 mm	50x3 mm	200	ET.00.TKPD.BB41.503	ET.00.TPP
50x4 mm	50x4 mm	200	ET.00.TKPD.BB41.504	ET.00.TPP
50x5 mm	50x5 mm	200	ET.00.TKPD.BB41.505	ET.00.TPP
50x6 mm	50x6 mm	200	ET.00.TKPD.BB41.506	ET.00.TPP

Baradan Topraklama Elektroduna

Bar to Earth Rod

Elektrod Ölçüsü (a)	İletken Ölçüsü (b)	Kaynak Tozu (gr)	Pota	Pense Modeli
Rod Diameter (a)	Conductor Diameter (b)	Welding Powder (gr)	Mould	Handle Clamp
16.0 mm	20x3 mm	90	ET.00.TKPC.BE1.16203	ET.00.TPP
16.0 mm	25x2 mm	90	ET.00.TKPC.BE1.16252	ET.00.TPP
16.0 mm	25x3 mm	90	ET.00.TKPC.BE1.16253	ET.00.TPP
16.0 mm	25x4 mm	115	ET.00.TKPC.BE1.16254	ET.00.TPP
16.0 mm	30x2 mm	115	ET.00.TKPC.BE1.16302	ET.00.TPP
16.0 mm	30x3 mm	115	ET.00.TKPC.BE1.16303	ET.00.TPP
16.0 mm	30x4 mm	150	ET.00.TKPC.BE1.16304	ET.00.TPP
16.0 mm	30x5 mm	150	ET.00.TKPC.BE1.16305	ET.00.TPP
16.0 mm	40x3 mm	150	ET.00.TKPC.BE1.16403	ET.00.TPP
16.0 mm	40x4 mm	150	ET.00.TKPC.BE1.16404	ET.00.TPP
16.0 mm	40x5 mm	150	ET.00.TKPC.BE1.16405	ET.00.TPP
16.0 mm	40x6 mm	150	ET.00.TKPC.BE1.16406	ET.00.TPP
16.0 mm	50x3 mm	150	ET.00.TKPC.BE1.16503	ET.00.TPP
16.0 mm	50x4 mm	200	ET.00.TKPC.BE1.16504	ET.00.TPP
16.0 mm	50x5 mm	200	ET.00.TKPC.BE1.16505	ET.00.TPP
16.0 mm	50x6 mm	200	ET.00.TKPC.BE1.16506	ET.00.TPP
18.0 mm	20x3 mm	115	ET.00.TKPC.BE1.18203	ET.00.TPP
18.0 mm	25x2 mm	150	ET.00.TKPC.BE1.18252	ET.00.TPP
18.0 mm	25x3 mm	150	ET.00.TKPC.BE1.18253	ET.00.TPP
18.0 mm	25x4 mm	150	ET.00.TKPC.BE1.18254	ET.00.TPP
18.0 mm	30x2 mm	150	ET.00.TKPC.BE1.18302	ET.00.TPP
18.0 mm	30x3 mm	150	ET.00.TKPC.BE1.18303	ET.00.TPP
18.0 mm	30x4 mm	150	ET.00.TKPC.BE1.18304	ET.00.TPP
18.0 mm	30x5 mm	200	ET.00.TKPC.BE1.18305	ET.00.TPP
18.0 mm	40x3 mm	200	ET.00.TKPC.BE1.18403	ET.00.TPP
18.0 mm	40x4 mm	200	ET.00.TKPC.BE1.18404	ET.00.TPP
18.0 mm	40x5 mm	200	ET.00.TKPC.BE1.18405	ET.00.TPP
18.0 mm	40x6 mm	200	ET.00.TKPC.BE1.18406	ET.00.TPP
18.0 mm	50x3 mm	250	ET.00.TKPC.BE1.18503	ET.00.TPP
18.0 mm	50x4 mm	250	ET.00.TKPC.BE1.18504	ET.00.TPP
18.0 mm	50x5 mm	250	ET.00.TKPC.BE1.18505	ET.00.TPP
18.0 mm	50x6 mm	250	ET.00.TKPC.BE1.18506	ET.00.TPP
20.0 mm	20x3 mm	150	ET.00.TKPC.BE1.20203	ET.00.TPP
20.0 mm	25x2 mm	150	ET.00.TKPC.BE1.20252	ET.00.TPP
20.0 mm	25x3 mm	150	ET.00.TKPC.BE1.20253	ET.00.TPP
20.0 mm	25x4 mm	200	ET.00.TKPC.BE1.20254	ET.00.TPP
20.0 mm	30x2 mm	200	ET.00.TKPC.BE1.20302	ET.00.TPP
20.0 mm	30x3 mm	200	ET.00.TKPC.BE1.20303	ET.00.TPP
20.0 mm	30x4 mm	250	ET.00.TKPC.BE1.20304	ET.00.TPP
20.0 mm	30x5 mm	250	ET.00.TKPC.BE1.20305	ET.00.TPP
20.0 mm	40x3 mm	250	ET.00.TKPC.BE1.20403	ET.00.TPP
20.0 mm	40x4 mm	250	ET.00.TKPC.BE1.20404	ET.00.TPP
20.0 mm	40x5 mm	250	ET.00.TKPC.BE1.20405	ET.00.TPP
20.0 mm	40x6 mm	250	ET.00.TKPC.BE1.20406	ET.00.TPP
20.0 mm	50x3 mm	2x150	ET.00.TKPC.BE1.20503	ET.00.TPP
20.0 mm	50x4 mm	2x150	ET.00.TKPC.BE1.20504	ET.00.TPP
20.0 mm	50x5 mm	2x150	ET.00.TKPC.BE1.20505	ET.00.TPP
20.0 mm	50x6 mm	2x150	ET.00.TKPC.BE1.20506	ET.00.TPP

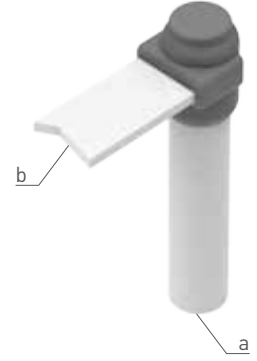

Baradan Topraklama Elektroduna

Bar to Earth Rod

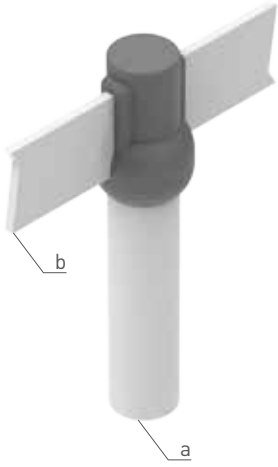

Elektrod Ölçüsü (a)	İletken Ölçüsü (b)	Kaynak Tozu (gr)	Pota	Pense Modeli
Rod Diameter (a)	Conductor Diameter (b)	Welding Powder (gr)	Mould	Handle Clamp
16.0 mm	20x3 mm	90	ET.00.TKPC.BE2.16203	ET.00.TPP
16.0 mm	25x2 mm	90	ET.00.TKPC.BE2.16252	ET.00.TPP
16.0 mm	25x3 mm	90	ET.00.TKPC.BE2.16253	ET.00.TPP
16.0 mm	25x4 mm	115	ET.00.TKPC.BE2.16254	ET.00.TPP
16.0 mm	30x2 mm	115	ET.00.TKPC.BE2.16302	ET.00.TPP
16.0 mm	30x3 mm	115	ET.00.TKPC.BE2.16303	ET.00.TPP
16.0 mm	30x4 mm	150	ET.00.TKPC.BE2.16304	ET.00.TPP
16.0 mm	30x5 mm	150	ET.00.TKPC.BE2.16305	ET.00.TPP
16.0 mm	40x3 mm	150	ET.00.TKPC.BE2.16403	ET.00.TPP
16.0 mm	40x4 mm	150	ET.00.TKPC.BE2.16404	ET.00.TPP
16.0 mm	40x5 mm	150	ET.00.TKPC.BE2.16405	ET.00.TPP
16.0 mm	40x6 mm	150	ET.00.TKPC.BE2.16406	ET.00.TPP
16.0 mm	50x3 mm	150	ET.00.TKPC.BE2.16503	ET.00.TPP
16.0 mm	50x4 mm	200	ET.00.TKPC.BE2.16504	ET.00.TPP
16.0 mm	50x5 mm	200	ET.00.TKPC.BE2.16505	ET.00.TPP
16.0 mm	50x6 mm	200	ET.00.TKPC.BE2.16506	ET.00.TPP
18.0 mm	20x3 mm	115	ET.00.TKPC.BE2.18203	ET.00.TPP
18.0 mm	25x2 mm	150	ET.00.TKPC.BE2.18252	ET.00.TPP
18.0 mm	25x3 mm	150	ET.00.TKPC.BE2.18253	ET.00.TPP
18.0 mm	25x4 mm	150	ET.00.TKPC.BE2.18254	ET.00.TPP
18.0 mm	30x2 mm	150	ET.00.TKPC.BE2.18302	ET.00.TPP
18.0 mm	30x3 mm	150	ET.00.TKPC.BE2.18303	ET.00.TPP
18.0 mm	30x4 mm	150	ET.00.TKPC.BE2.18304	ET.00.TPP
18.0 mm	30x5 mm	200	ET.00.TKPC.BE2.18305	ET.00.TPP
18.0 mm	40x3 mm	200	ET.00.TKPC.BE2.18403	ET.00.TPP
18.0 mm	40x4 mm	200	ET.00.TKPC.BE2.18404	ET.00.TPP
18.0 mm	40x5 mm	200	ET.00.TKPC.BE2.18405	ET.00.TPP
18.0 mm	40x6 mm	200	ET.00.TKPC.BE2.18406	ET.00.TPP
18.0 mm	50x3 mm	250	ET.00.TKPC.BE2.18503	ET.00.TPP
18.0 mm	50x4 mm	250	ET.00.TKPC.BE2.18504	ET.00.TPP
18.0 mm	50x5 mm	250	ET.00.TKPC.BE2.18505	ET.00.TPP
18.0 mm	50x6 mm	250	ET.00.TKPC.BE2.18506	ET.00.TPP
20.0 mm	20x3 mm	150	ET.00.TKPC.BE2.20203	ET.00.TPP
20.0 mm	25x2 mm	150	ET.00.TKPC.BE2.20252	ET.00.TPP
20.0 mm	25x3 mm	150	ET.00.TKPC.BE2.20253	ET.00.TPP
20.0 mm	25x4 mm	200	ET.00.TKPC.BE2.20254	ET.00.TPP
20.0 mm	30x2 mm	200	ET.00.TKPC.BE2.20302	ET.00.TPP
20.0 mm	30x3 mm	200	ET.00.TKPC.BE2.20303	ET.00.TPP
20.0 mm	30x4 mm	250	ET.00.TKPC.BE2.20304	ET.00.TPP
20.0 mm	30x5 mm	250	ET.00.TKPC.BE2.20305	ET.00.TPP
20.0 mm	40x3 mm	250	ET.00.TKPC.BE2.20403	ET.00.TPP
20.0 mm	40x4 mm	250	ET.00.TKPC.BE2.20404	ET.00.TPP
20.0 mm	40x5 mm	250	ET.00.TKPC.BE2.20405	ET.00.TPP
20.0 mm	40x6 mm	250	ET.00.TKPC.BE2.20406	ET.00.TPP
20.0 mm	50x3 mm	2x150	ET.00.TKPC.BE2.20503	ET.00.TPP
20.0 mm	50x4 mm	2x150	ET.00.TKPC.BE2.20504	ET.00.TPP
20.0 mm	50x5 mm	2x150	ET.00.TKPC.BE2.20505	ET.00.TPP
20.0 mm	50x6 mm	2x150	ET.00.TKPC.BE2.20506	ET.00.TPP

Baradan Çelik Yüze
Bar to Steel Surface

İletken Ölçüsü	Kaynak Tozu (gr)	Pota	Pense Modeli
Conductor Diameter	Welding Powder (gr)	Mould	Handle Clamp
20x3 mm	65	ET.00.TKPC.BS1.203	ET.00.TPP
25x2 mm	90	ET.00.TKPC.BS1.252	ET.00.TPP
25x3 mm	90	ET.00.TKPC.BS1.253	ET.00.TPP
25x4 mm	90	ET.00.TKPC.BS1.254	ET.00.TPP
30x2 mm	90	ET.00.TKPC.BS1.302	ET.00.TPP
30x3 mm	90	ET.00.TKPC.BS1.303	ET.00.TPP
30x4 mm	115	ET.00.TKPC.BS1.304	ET.00.TPP
30x5 mm	150	ET.00.TKPC.BS1.305	ET.00.TPP
40x3 mm	150	ET.00.TKPC.BS1.403	ET.00.TPP
40x4 mm	200	ET.00.TKPC.BS1.404	ET.00.TPP
40x5 mm	200	ET.00.TKPC.BS1.405	ET.00.TPP
40x6 mm	250	ET.00.TKPC.BS1.406	ET.00.TPP
50x3 mm	200	ET.00.TKPD.BS1.503	ET.00.TPP
50x4 mm	250	ET.00.TKPD.BS1.504	ET.00.TPP
50x5 mm	250	ET.00.TKPD.BS1.505	ET.00.TPP
50x6 mm	2x150	ET.00.TKPD.BS1.506	ET.00.TPP



Baradan Çelik Yüze
Bar to Steel Surface

İletken Ölçüsü	Kaynak Tozu (gr)	Pota	Pense Modeli
Conductor Diameter	Welding Powder (gr)	Mould	Handle Clamp
20x3 mm	90	ET.00.TKPC.BS2.203	ET.00.TPP
25x2 mm	90	ET.00.TKPC.BS2.252	ET.00.TPP
25x3 mm	90	ET.00.TKPC.BS2.253	ET.00.TPP
25x4 mm	90	ET.00.TKPC.BS2.254	ET.00.TPP
30x2 mm	115	ET.00.TKPC.BS2.302	ET.00.TPP
30x3 mm	115	ET.00.TKPC.BS2.303	ET.00.TPP
30x4 mm	150	ET.00.TKPC.BS2.304	ET.00.TPP
30x5 mm	200	ET.00.TKPC.BS2.305	ET.00.TPP
40x3 mm	115	ET.00.TKPC.BS2.403	ET.00.TPP
40x4 mm	200	ET.00.TKPC.BS2.404	ET.00.TPP
40x5 mm	200	ET.00.TKPC.BS2.405	ET.00.TPP
40x6 mm	250	ET.00.TKPC.BS2.406	ET.00.TPP
50x3 mm	200	ET.00.TKPD.BS2.503	ET.00.TPP
50x4 mm	2x150	ET.00.TKPD.BS2.504	ET.00.TPP
50x5 mm	2x150	ET.00.TKPD.BS2.505	ET.00.TPP
50x6 mm	2x150	ET.00.TKPD.BS2.506	ET.00.TPP

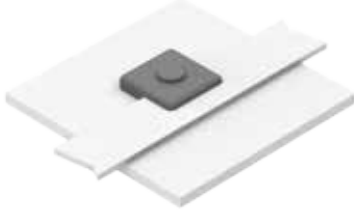

Baradan Çelik Yüze
Bar to Steel Surface

İletken Ölçüsü	Kaynak Tozu (gr)	Pota	Pense Modeli
Conductor Diameter	Welding Powder (gr)	Mould	Handle Clamp
20x3 mm	65	ET.00.TKPC.BS3.203	ET.00.TPP
25x2 mm	90	ET.00.TKPC.BS3.252	ET.00.TPP
25x3 mm	90	ET.00.TKPC.BS3.253	ET.00.TPP
25x4 mm	115	ET.00.TKPC.BS3.254	ET.00.TPP
30x2 mm	150	ET.00.TKPC.BS3.302	ET.00.TPP
30x3 mm	115	ET.00.TKPC.BS3.303	ET.00.TPP
30x4 mm	115	ET.00.TKPC.BS3.304	ET.00.TPP
30x5 mm	150	ET.00.TKPC.BS3.305	ET.00.TPP
40x3 mm	150	ET.00.TKPC.BS3.403	ET.00.TPP
40x4 mm	200	ET.00.TKPC.BS3.404	ET.00.TPP
40x5 mm	250	ET.00.TKPC.BS3.405	ET.00.TPP
40x6 mm	250	ET.00.TKPC.BS3.406	ET.00.TPP
50x3 mm	250	ET.00.TKPD.BS3.503	ET.00.TPP
50x4 mm	250	ET.00.TKPD.BS3.504	ET.00.TPP
50x5 mm	250	ET.00.TKPD.BS3.505	ET.00.TPP
50x6 mm	250	ET.00.TKPD.BS3.506	ET.00.TPP

Kablodan Baraya

Cable to Bar

İletken Ölçüsü (a)	İletken Ölçüsü (b)	Kaynak Tozu (gr)	Pota	Pense Modeli
Conductor Diameter (a)	Conductor Diameter (b)	Welding Powder (gr)	Mould	Handle Clamp
16 mm ²	20x3 mm	45	ET.00.TKPC.CB1.16203	ET.00.TPP
16 mm ²	25x3 mm	45	ET.00.TKPC.CB1.16253	ET.00.TPP
25 mm ²	20x3 mm	45	ET.00.TKPC.CB1.25203	ET.00.TPP
25 mm ²	25x3 mm	45	ET.00.TKPC.CB1.25253	ET.00.TPP
35 mm ²	20x3 mm	45	ET.00.TKPC.CB1.35203	ET.00.TPP
35 mm ²	25x3 mm	45	ET.00.TKPC.CB1.35253	ET.00.TPP
50 mm ²	20x3 mm	45	ET.00.TKPC.CB1.50203	ET.00.TPP
50 mm ²	25x3 mm	65	ET.00.TKPC.CB1.50253	ET.00.TPP
50 mm ²	30x3 mm	65	ET.00.TKPC.CB1.50303	ET.00.TPP
50 mm ²	30x3.5 mm	65	ET.00.TKPC.CB1.503035	ET.00.TPP
8.0 mm	20x3 mm	45	ET.00.TKPC.CB1.08203	ET.00.TPP
8.0 mm	25x3 mm	45	ET.00.TKPC.CB1.08253	ET.00.TPP
8.0 mm	30x3 mm	65	ET.00.TKPC.CB1.08303	ET.00.TPP
8.0 mm	30x3.5 mm	65	ET.00.TKPC.CB1.083035	ET.00.TPP
70 mm ²	25x3 mm	65	ET.00.TKPC.CB1.70253	ET.00.TPP
70 mm ²	30x3 mm	65	ET.00.TKPC.CB1.70303	ET.00.TPP
70 mm ²	30x3.5 mm	90	ET.00.TKPC.CB1.703035	ET.00.TPP
70 mm ²	40x4 mm	90	ET.00.TKPC.CB1.70404	ET.00.TPP
10.0 mm	25x3 mm	65	ET.00.TKPC.CB1.10253	ET.00.TPP
10.0 mm	30x3 mm	65	ET.00.TKPC.CB1.10303	ET.00.TPP
10.0 mm	30x3.5 mm	65	ET.00.TKPC.CB1.103035	ET.00.TPP
10.0 mm	40x4 mm	90	ET.00.TKPC.CB1.10404	ET.00.TPP
95 mm ²	25x3 mm	90	ET.00.TKPC.CB1.95253	ET.00.TPP
95 mm ²	30x3 mm	90	ET.00.TKPC.CB1.95303	ET.00.TPP
95 mm ²	30x3.5 mm	90	ET.00.TKPC.CB1.953035	ET.00.TPP
95 mm ²	40x4 mm	115	ET.00.TKPC.CB1.95404	ET.00.TPP
120 mm ²	25x3 mm	90	ET.00.TKPC.CB1.120253	ET.00.TPP
120 mm ²	30x3 mm	90	ET.00.TKPC.CB1.120303	ET.00.TPP
120 mm ²	30x3.5 mm	90	ET.00.TKPC.CB1.1203035	ET.00.TPP
120 mm ²	30x5 mm	115	ET.00.TKPC.CB1.120305	ET.00.TPP
120 mm ²	40x4 mm	115	ET.00.TKPC.CB1.120404	ET.00.TPP
150 mm ²	30x5 mm	115	ET.00.TKPC.CB1.150305	ET.00.TPP
150 mm ²	40x5 mm	150	ET.00.TKPC.CB1.150405	ET.00.TPP
185 mm ²	40x5 mm	150	ET.00.TKPC.CB1.185405	ET.00.TPP
185 mm ²	50x5 mm	200	ET.00.TKPC.CB1.185505	ET.00.TPP
240 mm ²	50x5 mm	200	ET.00.TKPC.CB1.240505	ET.00.TPP
240 mm ²	50x6 mm	250	ET.00.TKPC.CB1.240506	ET.00.TPP
300 mm ²	50x6 mm	2x150	ET.00.TKPC.CB1.300506	ET.00.TPP

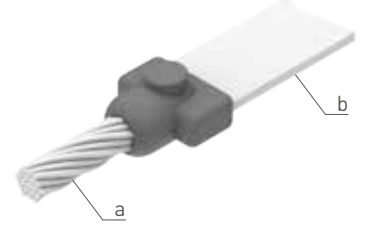

Kablodan Baraya

Cable to Bar

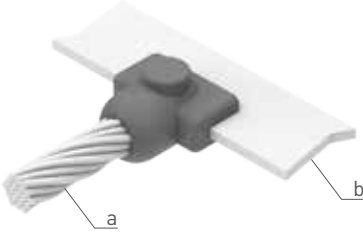

İletken Ölçüsü (a)	İletken Ölçüsü (b)	Kaynak Tozu (gr)	Pota	Pense Modeli
Conductor Diameter (a)	Conductor Diameter (b)	Welding Powder (gr)	Mould	Handle Clamp
16 mm ²	20x3 mm	45	ET.00.TKPC.CB4.16203	ET.00.TPP
16 mm ²	25x3 mm	45	ET.00.TKPC.CB4.16253	ET.00.TPP
25 mm ²	20x3 mm	45	ET.00.TKPC.CB4.25203	ET.00.TPP
25 mm ²	25x3 mm	45	ET.00.TKPC.CB4.25253	ET.00.TPP
35 mm ²	20x3 mm	45	ET.00.TKPC.CB4.35203	ET.00.TPP
35 mm ²	25x3 mm	45	ET.00.TKPC.CB4.35253	ET.00.TPP
50 mm ²	20x3 mm	45	ET.00.TKPC.CB4.50203	ET.00.TPP
50 mm ²	25x3 mm	45	ET.00.TKPC.CB4.50253	ET.00.TPP
50 mm ²	30x3 mm	65	ET.00.TKPC.CB4.50303	ET.00.TPP
50 mm ²	30x3.5 mm	65	ET.00.TKPC.CB4.503035	ET.00.TPP
8.0 mm	20x3 mm	45	ET.00.TKPC.CB4.08203	ET.00.TPP
8.0 mm	25x3 mm	45	ET.00.TKPC.CB4.08253	ET.00.TPP
8.0 mm	30x3 mm	65	ET.00.TKPC.CB4.08303	ET.00.TPP
8.0 mm	30x3.5 mm	65	ET.00.TKPC.CB4.083035	ET.00.TPP
70 mm ²	25x3 mm	65	ET.00.TKPC.CB4.70253	ET.00.TPP
70 mm ²	30x3 mm	65	ET.00.TKPC.CB4.70303	ET.00.TPP
70 mm ²	30x3.5 mm	90	ET.00.TKPC.CB4.703035	ET.00.TPP
70 mm ²	40x4 mm	90	ET.00.TKPC.CB4.70404	ET.00.TPP
10.0 mm	25x3 mm	65	ET.00.TKPC.CB4.10253	ET.00.TPP
10.0 mm	30x3 mm	65	ET.00.TKPC.CB4.10303	ET.00.TPP
10.0 mm	30x3.5 mm	65	ET.00.TKPC.CB4.103035	ET.00.TPP
10.0 mm	40x4 mm	90	ET.00.TKPC.CB4.10404	ET.00.TPP
95 mm ²	25x3 mm	90	ET.00.TKPC.CB4.95253	ET.00.TPP
95 mm ²	30x3 mm	90	ET.00.TKPC.CB4.95303	ET.00.TPP
95 mm ²	30x3.5 mm	90	ET.00.TKPC.CB4.953035	ET.00.TPP
95 mm ²	40x4 mm	115	ET.00.TKPC.CB4.95404	ET.00.TPP
120 mm ²	25x3 mm	90	ET.00.TKPC.CB4.120253	ET.00.TPP
120 mm ²	30x3 mm	90	ET.00.TKPC.CB4.120303	ET.00.TPP
120 mm ²	30x3.5 mm	90	ET.00.TKPC.CB4.1203035	ET.00.TPP
120 mm ²	30x5 mm	115	ET.00.TKPC.CB4.120305	ET.00.TPP
120 mm ²	40x4 mm	115	ET.00.TKPC.CB4.120404	ET.00.TPP
150 mm ²	30x5 mm	115	ET.00.TKPC.CB4.150305	ET.00.TPP
150 mm ²	40x5 mm	150	ET.00.TKPC.CB4.150405	ET.00.TPP
185 mm ²	40x5 mm	150	ET.00.TKPC.CB4.185405	ET.00.TPP
185 mm ²	50x5 mm	200	ET.00.TKPD.CB4.185505	ET.00.TPP
240 mm ²	50x5 mm	200	ET.00.TKPD.CB4.240505	ET.00.TPP
240 mm ²	50x6 mm	250	ET.00.TKPD.CB4.240506	ET.00.TPP
300 mm ²	50x6 mm	2x150	ET.00.TKPD.CB4.300506	ET.00.TPP

Kablodan Baraya

Cable to Bar

İletken Ölçüsü (a)	İletken Ölçüsü (b)	Kaynak Tozu (gr)	Pota	Pense Modeli
Conductor Diameter (a)	Conductor Diameter (b)	Welding Powder (gr)	Mould	Handle Clamp
16 mm ²	20x3 mm	45	ET.00.TKPC.CB5.16203	ET.00.TPP
16 mm ²	25x3 mm	65	ET.00.TKPC.CB5.16253	ET.00.TPP
25 mm ²	20x3 mm	45	ET.00.TKPC.CB5.25203	ET.00.TPP
25 mm ²	25x3 mm	65	ET.00.TKPC.CB5.25253	ET.00.TPP
35 mm ²	20x3 mm	45	ET.00.TKPC.CB5.35203	ET.00.TPP
35 mm ²	25x3 mm	65	ET.00.TKPC.CB5.35253	ET.00.TPP
50 mm ²	20x3 mm	65	ET.00.TKPC.CB5.50203	ET.00.TPP
50 mm ²	25x3 mm	65	ET.00.TKPC.CB5.50253	ET.00.TPP
50 mm ²	30x3 mm	90	ET.00.TKPC.CB5.50303	ET.00.TPP
50 mm ²	30x3.5 mm	90	ET.00.TKPC.CB5.503035	ET.00.TPP
8.0 mm	20x3 mm	65	ET.00.TKPC.CB5.08203	ET.00.TPP
8.0 mm	25x3 mm	65	ET.00.TKPC.CB5.08253	ET.00.TPP
8.0 mm	30x3 mm	90	ET.00.TKPC.CB5.08303	ET.00.TPP
8.0 mm	30x3.5 mm	90	ET.00.TKPC.CB5.083035	ET.00.TPP
70 mm ²	25x3 mm	90	ET.00.TKPC.CB5.70253	ET.00.TPP
70 mm ²	30x3 mm	115	ET.00.TKPC.CB5.70303	ET.00.TPP
70 mm ²	30x3.5 mm	115	ET.00.TKPC.CB5.703035	ET.00.TPP
70 mm ²	40x4 mm	150	ET.00.TKPC.CB5.70404	ET.00.TPP
10.0 mm	25x3 mm	115	ET.00.TKPC.CB5.10253	ET.00.TPP
10.0 mm	30x3 mm	115	ET.00.TKPC.CB5.10303	ET.00.TPP
10.0 mm	30x3.5 mm	115	ET.00.TKPC.CB5.103035	ET.00.TPP
10.0 mm	40x4 mm	150	ET.00.TKPC.CB5.10404	ET.00.TPP
95 mm ²	25x3 mm	150	ET.00.TKPC.CB5.95253	ET.00.TPP
95 mm ²	30x3 mm	150	ET.00.TKPC.CB5.95303	ET.00.TPP
95 mm ²	30x3.5 mm	150	ET.00.TKPC.CB5.953035	ET.00.TPP
95 mm ²	40x4 mm	200	ET.00.TKPC.CB5.95404	ET.00.TPP
120 mm ²	25x3 mm	150	ET.00.TKPC.CB5.120253	ET.00.TPP
120 mm ²	30x3 mm	150	ET.00.TKPC.CB5.120303	ET.00.TPP
120 mm ²	30x3.5 mm	150	ET.00.TKPC.CB5.1203035	ET.00.TPP
120 mm ²	30x5 mm	200	ET.00.TKPC.CB5.120305	ET.00.TPP
120 mm ²	40x4 mm	200	ET.00.TKPC.CB5.120404	ET.00.TPP
150 mm ²	30x5 mm	200	ET.00.TKPC.CB5.150305	ET.00.TPP
150 mm ²	40x5 mm	250	ET.00.TKPC.CB5.150405	ET.00.TPP
185 mm ²	40x5 mm	250	ET.00.TKPC.CB5.185405	ET.00.TPP
185 mm ²	50x5 mm	2x150	ET.00.TKRD.CB5.185505	ET.00.TPP
240 mm ²	50x5 mm	2x150	ET.00.TKRD.CB5.240505	ET.00.TPP
240 mm ²	50x6 mm	2x200	ET.00.TKRD.CB5.240506	ET.00.TPP
300 mm ²	50x6 mm	2x250	ET.00.TKRD.CB5.300506	ET.00.TPP

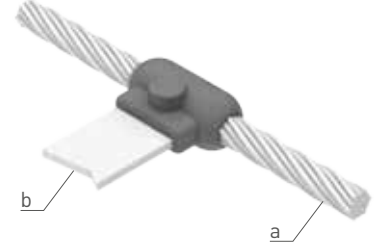

Kablodan Kabloya

Cable to Cable

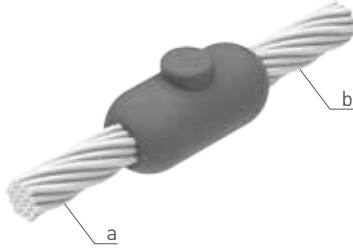

İletken Ölçüsü (a)	İletken Ölçüsü (b)	Kaynak Tozu (gr)	Pota	Pense Modeli
Conductor Diameter (a)	Conductor Diameter (b)	Welding Powder (gr)	Mould	Handle Clamp
16 mm ²	16 mm ²	32	ET.00.TKPC.CC1.16	ET.00.TPP
25 mm ²	25 mm ²	32	ET.00.TKPC.CC1.25	ET.00.TPP
25 mm ²	16 mm ²	32	ET.00.TKPC.CC1.2516	ET.00.TPP
35 mm ²	35 mm ²	32	ET.00.TKPC.CC1.35	ET.00.TPP
35 mm ²	16 mm ²	32	ET.00.TKPC.CC1.3516	ET.00.TPP
35 mm ²	25 mm ²	32	ET.00.TKPC.CC1.3525	ET.00.TPP
50 mm ²	50 mm ²	45	ET.00.TKPC.CC1.50	ET.00.TPP
50 mm ²	16 mm ²	45	ET.00.TKPC.CC1.5016	ET.00.TPP
50 mm ²	25 mm ²	45	ET.00.TKPC.CC1.5025	ET.00.TPP
50 mm ²	35 mm ²	45	ET.00.TKPC.CC1.5035	ET.00.TPP
8.0 mm	8.0 mm	45	ET.00.TKPC.CC1.08	ET.00.TPP
8.0 mm	50 mm ²	45	ET.00.TKPC.CC1.0850	ET.00.TPP
70 mm ²	70 mm ²	65	ET.00.TKPC.CC1.70	ET.00.TPP
70 mm ²	50 mm ²	65	ET.00.TKPC.CC1.7050	ET.00.TPP
70 mm ²	35 mm ²	65	ET.00.TKPC.CC1.7035	ET.00.TPP
70 mm ²	25 mm ²	65	ET.00.TKPC.CC1.7025	ET.00.TPP
10.0 mm	10.0 mm	65	ET.00.TKPC.CC1.10	ET.00.TPP
95 mm ²	95 mm ²	90	ET.00.TKPC.CC1.95	ET.00.TPP
95 mm ²	70 mm ²	90	ET.00.TKPC.CC1.9570	ET.00.TPP
95 mm ²	50 mm ²	90	ET.00.TKPC.CC1.9550	ET.00.TPP
95 mm ²	35 mm ²	90	ET.00.TKPC.CC1.9535	ET.00.TPP
120 mm ²	120 mm ²	115	ET.00.TKPC.CC1.120	ET.00.TPP
120 mm ²	95 mm ²	115	ET.00.TKPC.CC1.12095	ET.00.TPP
120 mm ²	70 mm ²	115	ET.00.TKPC.CC1.12070	ET.00.TPP
120 mm ²	50 mm ²	115	ET.00.TKPC.CC1.12050	ET.00.TPP
150 mm ²	150 mm ²	115	ET.00.TKPC.CC1.150	ET.00.TPP
150 mm ²	120 mm ²	115	ET.00.TKPC.CC1.150120	ET.00.TPP
150 mm ²	95 mm ²	115	ET.00.TKPC.CC1.15095	ET.00.TPP
150 mm ²	70 mm ²	115	ET.00.TKPC.CC1.15070	ET.00.TPP
185 mm ²	185 mm ²	150	ET.00.TKPC.CC1.185	ET.00.TPP
185 mm ²	150 mm ²	150	ET.00.TKPC.CC1.185150	ET.00.TPP
185 mm ²	120 mm ²	150	ET.00.TKPC.CC1.185120	ET.00.TPP
185 mm ²	95 mm ²	150	ET.00.TKPC.CC1.18595	ET.00.TPP
240 mm ²	240 mm ²	200	ET.00.TKPC.CC1.240	ET.00.TPP
240 mm ²	185 mm ²	200	ET.00.TKPC.CC1.240185	ET.00.TPP
240 mm ²	150 mm ²	200	ET.00.TKPC.CC1.240150	ET.00.TPP
240 mm ²	120 mm ²	200	ET.00.TKPC.CC1.240120	ET.00.TPP
300 mm ²	300 mm ²	250	ET.00.TKPC.CC1.300	ET.00.TPP
300 mm ²	240 mm ²	250	ET.00.TKPC.CC1.300240	ET.00.TPP
300 mm ²	185 mm ²	250	ET.00.TKPC.CC1.300185	ET.00.TPP
300 mm ²	150 mm ²	250	ET.00.TKPC.CC1.300150	ET.00.TPP

Kablodan Kabloya

Cable to Cable

İletken Ölçüsü (a)	İletken Ölçüsü (b)	Kaynak Tozu (gr)	Pota	Pense Modeli
Conductor Diameter (a)	Conductor Diameter (b)	Welding Powder (gr)	Mould	Handle Clamp
16 mm ²	16 mm ²	45	ET.00.TKPC.CC2.16	ET.00.TPP
25 mm ²	25 mm ²	45	ET.00.TKPC.CC2.25	ET.00.TPP
25 mm ²	16 mm ²	45	ET.00.TKPC.CC2.2516	ET.00.TPP
35 mm ²	35 mm ²	45	ET.00.TKPC.CC2.35	ET.00.TPP
35 mm ²	16 mm ²	45	ET.00.TKPC.CC2.3516	ET.00.TPP
35 mm ²	25 mm ²	45	ET.00.TKPC.CC2.3525	ET.00.TPP
50 mm ²	50 mm ²	90	ET.00.TKPC.CC2.50	ET.00.TPP
50 mm ²	16 mm ²	65	ET.00.TKPC.CC2.5016	ET.00.TPP
50 mm ²	25 mm ²	65	ET.00.TKPC.CC2.5025	ET.00.TPP
50 mm ²	35 mm ²	65	ET.00.TKPC.CC2.5035	ET.00.TPP
8.0 mm	8.0 mm	65	ET.00.TKPC.CC2.08	ET.00.TPP
8.0 mm	50 mm ²	65	ET.00.TKPC.CC2.0850	ET.00.TPP
70 mm ²	70 mm ²	90	ET.00.TKPC.CC2.70	ET.00.TPP
70 mm ²	50 mm ²	90	ET.00.TKPC.CC2.7050	ET.00.TPP
70 mm ²	35 mm ²	65	ET.00.TKPC.CC2.7035	ET.00.TPP
70 mm ²	25 mm ²	65	ET.00.TKPC.CC2.7025	ET.00.TPP
10.0 mm	10.0 mm	90	ET.00.TKPC.CC2.10	ET.00.TPP
95 mm ²	95 mm ²	115	ET.00.TKPC.CC2.95	ET.00.TPP
95 mm ²	70 mm ²	90	ET.00.TKPC.CC2.9570	ET.00.TPP
95 mm ²	50 mm ²	90	ET.00.TKPC.CC2.9550	ET.00.TPP
95 mm ²	35 mm ²	90	ET.00.TKPC.CC2.9535	ET.00.TPP
120 mm ²	120 mm ²	150	ET.00.TKPC.CC2.120	ET.00.TPP
120 mm ²	95 mm ²	150	ET.00.TKPC.CC2.12095	ET.00.TPP
120 mm ²	70 mm ²	90	ET.00.TKPC.CC2.12070	ET.00.TPP
120 mm ²	50 mm ²	90	ET.00.TKPC.CC2.12050	ET.00.TPP
150 mm ²	150 mm ²	200	ET.00.TKPC.CC2.150	ET.00.TPP
150 mm ²	120 mm ²	150	ET.00.TKPC.CC2.150120	ET.00.TPP
150 mm ²	95 mm ²	150	ET.00.TKPC.CC2.15095	ET.00.TPP
150 mm ²	70 mm ²	90	ET.00.TKPC.CC2.15070	ET.00.TPP
185 mm ²	185 mm ²	200	ET.00.TKPC.CC2.185	ET.00.TPP
185 mm ²	150 mm ²	200	ET.00.TKPC.CC2.185150	ET.00.TPP
185 mm ²	120 mm ²	200	ET.00.TKPC.CC2.185120	ET.00.TPP
185 mm ²	95 mm ²	150	ET.00.TKPC.CC2.18595	ET.00.TPP
240 mm ²	240 mm ²	2x150	ET.00.TKPC.CC2.240	ET.00.TPP
240 mm ²	185 mm ²	200	ET.00.TKPC.CC2.240185	ET.00.TPP
240 mm ²	150 mm ²	200	ET.00.TKPC.CC2.240150	ET.00.TPP
240 mm ²	120 mm ²	200	ET.00.TKPC.CC2.240120	ET.00.TPP
300 mm ²	300 mm ²	2x200	ET.00.TKPD.CC2.300	ET.00.TPP
300 mm ²	240 mm ²	2x200	ET.00.TKPD.CC2.300240	ET.00.TPP
300 mm ²	185 mm ²	250	ET.00.TKPC.CC2.300185	ET.00.TPP
300 mm ²	150 mm ²	250	ET.00.TKPC.CC2.300150	ET.00.TPP

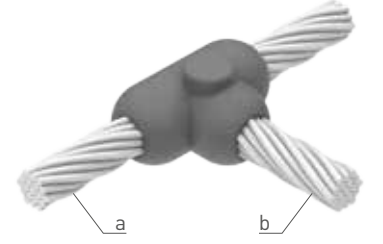

Kablodan Kabloya

Cable to Cable

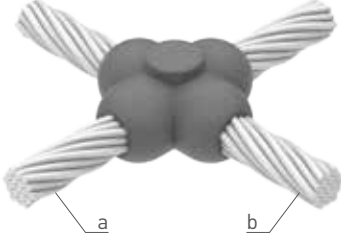

İletken Ölçüsü (a)	İletken Ölçüsü (b)	Kaynak Tozu (gr)	Pota	Pense Modeli
Conductor Diameter (a)	Conductor Diameter (b)	Welding Powder (gr)	Mould	Handle Clamp
16 mm ²	16 mm ²	45	ET.00.TKPC.CC4.16	ET.00.TPP
25 mm ²	25 mm ²	45	ET.00.TKPC.CC4.25	ET.00.TPP
25 mm ²	16 mm ²	45	ET.00.TKPC.CC4.2516	ET.00.TPP
35 mm ²	35 mm ²	65	ET.00.TKPC.CC4.35	ET.00.TPP
35 mm ²	16 mm ²	65	ET.00.TKPC.CC4.3516	ET.00.TPP
35 mm ²	25 mm ²	65	ET.00.TKPC.CC4.3525	ET.00.TPP
50 mm ²	50 mm ²	90	ET.00.TKPC.CC4.50	ET.00.TPP
50 mm ²	16 mm ²	90	ET.00.TKPC.CC4.5016	ET.00.TPP
50 mm ²	25 mm ²	90	ET.00.TKPC.CC4.5025	ET.00.TPP
50 mm ²	35 mm ²	90	ET.00.TKPC.CC4.5035	ET.00.TPP
8.0 mm	8.0 mm	90	ET.00.TKPC.CC4.08	ET.00.TPP
8.0 mm	50 mm ²	90	ET.00.TKPC.CC4.0850	ET.00.TPP
70 mm ²	70 mm ²	115	ET.00.TKPC.CC4.70	ET.00.TPP
70 mm ²	50 mm ²	115	ET.00.TKPC.CC4.7050	ET.00.TPP
70 mm ²	35 mm ²	115	ET.00.TKPC.CC4.7035	ET.00.TPP
70 mm ²	25 mm ²	115	ET.00.TKPC.CC4.7025	ET.00.TPP
10.0 mm	10.0 mm	115	ET.00.TKPC.CC4.10	ET.00.TPP
95 mm ²	95 mm ²	150	ET.00.TKPC.CC4.95	ET.00.TPP
95 mm ²	70 mm ²	150	ET.00.TKPC.CC4.9570	ET.00.TPP
95 mm ²	50 mm ²	115	ET.00.TKPC.CC4.9550	ET.00.TPP
95 mm ²	35 mm ²	115	ET.00.TKPC.CC4.9535	ET.00.TPP
120 mm ²	120 mm ²	200	ET.00.TKPC.CC4.120	ET.00.TPP
120 mm ²	95 mm ²	200	ET.00.TKPC.CC4.12095	ET.00.TPP
120 mm ²	70 mm ²	150	ET.00.TKPC.CC4.12070	ET.00.TPP
120 mm ²	50 mm ²	150	ET.00.TKPC.CC4.12050	ET.00.TPP
150 mm ²	150 mm ²	250	ET.00.TKPC.CC4.150	ET.00.TPP
150 mm ²	120 mm ²	250	ET.00.TKPC.CC4.150120	ET.00.TPP
150 mm ²	95 mm ²	200	ET.00.TKPC.CC4.15095	ET.00.TPP
150 mm ²	70 mm ²	150	ET.00.TKPC.CC4.15070	ET.00.TPP
185 mm ²	185 mm ²	2x150	ET.00.TKPC.CC4.185	ET.00.TPP
185 mm ²	150 mm ²	250	ET.00.TKPC.CC4.185150	ET.00.TPP
185 mm ²	120 mm ²	250	ET.00.TKPC.CC4.185120	ET.00.TPP
185 mm ²	95 mm ²	200	ET.00.TKPC.CC4.18595	ET.00.TPP
240 mm ²	240 mm ²	2x250	ET.00.TKPD.CC4.240	ET.00.TPP
240 mm ²	185 mm ²	2x200	ET.00.TKPD.CC4.240185	ET.00.TPP
240 mm ²	150 mm ²	2x200	ET.00.TKPD.CC4.240150	ET.00.TPP
240 mm ²	120 mm ²	2x150	ET.00.TKPD.CC4.240120	ET.00.TPP

Kablodan Kabloya

Cable to Cable

İletken Ölçüsü (a)	İletken Ölçüsü (b)	Kaynak Tozu (gr)	Pota	Pense Modeli
Conductor Diameter (a)	Conductor Diameter (b)	Welding Powder (gr)	Mould	Handle Clamp
16 mm ²	16 mm ²	45	ET.00.TKPC.CC6.16	ET.00.TPP
25 mm ²	25 mm ²	45	ET.00.TKPC.CC6.25	ET.00.TPP
25 mm ²	16 mm ²	45	ET.00.TKPC.CC6.2516	ET.00.TPP
35 mm ²	35 mm ²	65	ET.00.TKPC.CC6.35	ET.00.TPP
35 mm ²	16 mm ²	65	ET.00.TKPC.CC6.3516	ET.00.TPP
35 mm ²	25 mm ²	65	ET.00.TKPC.CC6.3525	ET.00.TPP
50 mm ²	50 mm ²	90	ET.00.TKPC.CC6.50	ET.00.TPP
50 mm ²	16 mm ²	65	ET.00.TKPC.CC6.5016	ET.00.TPP
50 mm ²	25 mm ²	65	ET.00.TKPC.CC6.5025	ET.00.TPP
50 mm ²	35 mm ²	65	ET.00.TKPC.CC6.5035	ET.00.TPP
8.0 mm	8.0 mm	90	ET.00.TKPC.CC6.08	ET.00.TPP
8.0 mm	50 mm ²	90	ET.00.TKPC.CC6.0850	ET.00.TPP
70 mm ²	70 mm ²	115	ET.00.TKPC.CC6.70	ET.00.TPP
70 mm ²	50 mm ²	115	ET.00.TKPC.CC6.7050	ET.00.TPP
70 mm ²	35 mm ²	90	ET.00.TKPC.CC6.7035	ET.00.TPP
70 mm ²	25 mm ²	90	ET.00.TKPC.CC6.7025	ET.00.TPP
10.0 mm	10.0 mm	115	ET.00.TKPC.CC6.10	ET.00.TPP
95 mm ²	95 mm ²	150	ET.00.TKPC.CC6.95	ET.00.TPP
95 mm ²	70 mm ²	115	ET.00.TKPC.CC6.9570	ET.00.TPP
95 mm ²	50 mm ²	115	ET.00.TKPC.CC6.9550	ET.00.TPP
95 mm ²	35 mm ²	115	ET.00.TKPC.CC6.9535	ET.00.TPP
120 mm ²	120 mm ²	200	ET.00.TKPC.CC6.120	ET.00.TPP
120 mm ²	95 mm ²	200	ET.00.TKPC.CC6.12095	ET.00.TPP
120 mm ²	70 mm ²	150	ET.00.TKPC.CC6.12070	ET.00.TPP
120 mm ²	50 mm ²	115	ET.00.TKPC.CC6.12050	ET.00.TPP
150 mm ²	150 mm ²	250	ET.00.TKPC.CC6.150	ET.00.TPP
150 mm ²	120 mm ²	250	ET.00.TKPC.CC6.150120	ET.00.TPP
150 mm ²	95 mm ²	200	ET.00.TKPC.CC6.15095	ET.00.TPP
150 mm ²	70 mm ²	150	ET.00.TKPC.CC6.15070	ET.00.TPP
185 mm ²	185 mm ²	2x150	ET.00.TKPC.CC6.185	ET.00.TPP
185 mm ²	150 mm ²	250	ET.00.TKPC.CC6.185150	ET.00.TPP
185 mm ²	120 mm ²	250	ET.00.TKPC.CC6.185120	ET.00.TPP
185 mm ²	95 mm ²	200	ET.00.TKPC.CC6.18595	ET.00.TPP
240 mm ²	240 mm ²	2x200	ET.00.TKPD.CC6.240	ET.00.TPP
240 mm ²	185 mm ²	2x150	ET.00.TKPD.CC6.240185	ET.00.TPP
240 mm ²	150 mm ²	2x150	ET.00.TKPD.CC6.240150	ET.00.TPP
240 mm ²	120 mm ²	250	ET.00.TKPD.CC6.240120	ET.00.TPP



Kablodan Kabloya

Cable to Cable

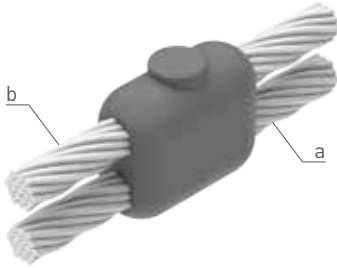

İletken Ölçüsü (a)	İletken Ölçüsü (b)	Kaynak Tozu (gr)	Pota	Pense Modeli
Conductor Diameter (a)	Conductor Diameter (b)	Welding Powder (gr)	Mould	Handle Clamp
16 mm ²	16 mm ²	45	ET.00.TKPC.CC7.16	ET.00.TPP
25 mm ²	25 mm ²	45	ET.00.TKPC.CC7.25	ET.00.TPP
25 mm ²	16 mm ²	45	ET.00.TKPC.CC7.2516	ET.00.TPP
35 mm ²	35 mm ²	65	ET.00.TKPC.CC7.35	ET.00.TPP
35 mm ²	16 mm ²	65	ET.00.TKPC.CC7.3516	ET.00.TPP
35 mm ²	25 mm ²	65	ET.00.TKPC.CC7.3525	ET.00.TPP
50 mm ²	50 mm ²	90	ET.00.TKPC.CC7.50	ET.00.TPP
50 mm ²	16 mm ²	65	ET.00.TKPC.CC7.5016	ET.00.TPP
50 mm ²	25 mm ²	65	ET.00.TKPC.CC7.5025	ET.00.TPP
50 mm ²	35 mm ²	90	ET.00.TKPC.CC7.5035	ET.00.TPP
8.0 mm	8.0 mm	90	ET.00.TKPC.CC7.08	ET.00.TPP
8.0 mm	50 mm ²	90	ET.00.TKPC.CC7.0850	ET.00.TPP
70 mm ²	70 mm ²	115	ET.00.TKPC.CC7.70	ET.00.TPP
70 mm ²	50 mm ²	115	ET.00.TKPC.CC7.7050	ET.00.TPP
70 mm ²	35 mm ²	90	ET.00.TKPC.CC7.7035	ET.00.TPP
70 mm ²	25 mm ²	90	ET.00.TKPC.CC7.7025	ET.00.TPP
10.0 mm	10.0 mm	115	ET.00.TKPC.CC7.10	ET.00.TPP
95 mm ²	95 mm ²	150	ET.00.TKPC.CC7.95	ET.00.TPP
95 mm ²	70 mm ²	115	ET.00.TKPC.CC7.9570	ET.00.TPP
95 mm ²	50 mm ²	115	ET.00.TKPC.CC7.9550	ET.00.TPP
95 mm ²	35 mm ²	115	ET.00.TKPC.CC7.9535	ET.00.TPP
120 mm ²	120 mm ²	200	ET.00.TKPC.CC7.120	ET.00.TPP
120 mm ²	95 mm ²	200	ET.00.TKPC.CC7.12095	ET.00.TPP
120 mm ²	70 mm ²	150	ET.00.TKPC.CC7.12070	ET.00.TPP
120 mm ²	50 mm ²	150	ET.00.TKPC.CC7.12050	ET.00.TPP
150 mm ²	150 mm ²	2x150	ET.00.TKPC.CC7.150	ET.00.TPP
150 mm ²	120 mm ²	250	ET.00.TKPC.CC7.150120	ET.00.TPP
150 mm ²	95 mm ²	200	ET.00.TKPC.CC7.15095	ET.00.TPP
150 mm ²	70 mm ²	150	ET.00.TKPC.CC7.15070	ET.00.TPP
185 mm ²	185 mm ²	2x150	ET.00.TKPC.CC7.185	ET.00.TPP
185 mm ²	150 mm ²	2X150	ET.00.TKPC.CC7.185150	ET.00.TPP
185 mm ²	120 mm ²	250	ET.00.TKPC.CC7.185120	ET.00.TPP
185 mm ²	95 mm ²	200	ET.00.TKPC.CC7.18595	ET.00.TPP
240 mm ²	240 mm ²	2x200	ET.00.TKPD.CC7.240	ET.00.TPP
240 mm ²	185 mm ²	2x200	ET.00.TKPD.CC7.240185	ET.00.TPP
240 mm ²	150 mm ²	2x150	ET.00.TKPD.CC7.240150	ET.00.TPP
240 mm ²	120 mm ²	250	ET.00.TKPD.CC7.240120	ET.00.TPP

Kablodan Kabloya

Cable to Cable

İletken Ölçüsü (a)	İletken Ölçüsü (b)	Kaynak Tozu (gr)	Pota	Pense Modeli
Conductor Diameter (a)	Conductor Diameter (b)	Welding Powder (gr)	Mould	Handle Clamp
16 mm ²	16 mm ²	65	ET.00.TKPC.CC11.16	ET.00.TPP
25 mm ²	25 mm ²	90	ET.00.TKPC.CC11.25	ET.00.TPP
25 mm ²	16 mm ²	90	ET.00.TKPC.CC11.2516	ET.00.TPP
35 mm ²	35 mm ²	115	ET.00.TKPC.CC11.35	ET.00.TPP
35 mm ²	16 mm ²	115	ET.00.TKPC.CC11.3516	ET.00.TPP
35 mm ²	25 mm ²	115	ET.00.TKPC.CC11.3525	ET.00.TPP
50 mm ²	50 mm ²	150	ET.00.TKPB.CC11.50	ET.00.TPP
50 mm ²	16 mm ²	115	ET.00.TKPB.CC11.5016	ET.00.TPP
50 mm ²	25 mm ²	115	ET.00.TKPB.CC11.5025	ET.00.TPP
50 mm ²	35 mm ²	150	ET.00.TKPB.CC11.5035	ET.00.TPP
8.0 mm	8.0 mm	150	ET.00.TKPC.CC11.08	ET.00.TPP
8.0 mm	50 mm ²	150	ET.00.TKPC.CC11.0850	ET.00.TPP
70 mm ²	70 mm ²	200	ET.00.TKPB.CC11.70	ET.00.TPP
70 mm ²	50 mm ²	200	ET.00.TKPB.CC11.7050	ET.00.TPP
70 mm ²	35 mm ²	150	ET.00.TKPB.CC11.7035	ET.00.TPP
70 mm ²	25 mm ²	150	ET.00.TKPB.CC11.7025	ET.00.TPP
10.0 mm	10.0 mm	150	ET.00.TKPC.CC11.10	ET.00.TPP
95 mm ²	95 mm ²	250	ET.00.TKPB.CC11.95	ET.00.TPP
95 mm ²	70 mm ²	250	ET.00.TKPB.CC11.9570	ET.00.TPP
95 mm ²	50 mm ²	200	ET.00.TKPB.CC11.9550	ET.00.TPP
95 mm ²	35 mm ²	200	ET.00.TKPB.CC11.9535	ET.00.TPP
120 mm ²	120 mm ²	2x150	ET.00.TKPB.CC11.120	ET.00.TPP
120 mm ²	95 mm ²	2x150	ET.00.TKPB.CC11.12095	ET.00.TPP
120 mm ²	70 mm ²	250	ET.00.TKPB.CC11.12070	ET.00.TPP
120 mm ²	50 mm ²	250	ET.00.TKPB.CC11.12050	ET.00.TPP
150 mm ²	150 mm ²	2x200	ET.00.TKPB.CC11.150	ET.00.TPP
150 mm ²	120 mm ²	2x200	ET.00.TKPB.CC11.150120	ET.00.TPP
150 mm ²	95 mm ²	2x150	ET.00.TKPB.CC11.15095	ET.00.TPP
150 mm ²	70 mm ²	2x150	ET.00.TKPB.CC11.15070	ET.00.TPP
185 mm ²	185 mm ²	2x250	ET.00.TKPB.CC11.185	ET.00.TPP
185 mm ²	150 mm ²	2x250	ET.00.TKPB.CC11.185150	ET.00.TPP
185 mm ²	120 mm ²	2x200	ET.00.TKPB.CC11.185120	ET.00.TPP
185 mm ²	95 mm ²	2x200	ET.00.TKPB.CC11.18595	ET.00.TPP
240 mm ²	240 mm ²	3x200	ET.00.TKPB.CC11.240	ET.00.TPP
240 mm ²	185 mm ²	3x200	ET.00.TKPB.CC11.240185	ET.00.TPP
240 mm ²	150 mm ²	2x250	ET.00.TKPB.CC11.240150	ET.00.TPP
240 mm ²	120 mm ²	2x250	ET.00.TKPB.CC11.240120	ET.00.TPP

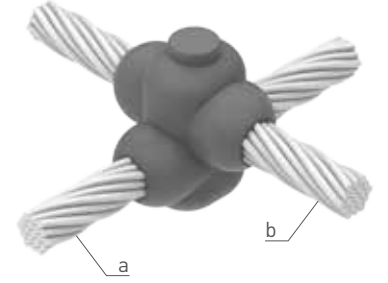

Kablodan Kabloya

Cable to Cable



İletke Ölçüsü (a)	İletken Ölçüsü (b)	Kaynak Tozu (gr)	Pota	Pense Modeli
Conductor Diameter (a)	Conductor Diameter (b)	Welding Powder (gr)	Mould	Handle Clamp
16 mm ²	16 mm ²	45	ET.00.TKPC.CC14.16	ET.00.TPP
25 mm ²	25 mm ²	45	ET.00.TKPC.CC14.25	ET.00.TPP
25 mm ²	16 mm ²	45	ET.00.TKPC.CC14.2516	ET.00.TPP
35 mm ²	35 mm ²	65	ET.00.TKPC.CC14.35	ET.00.TPP
35 mm ²	16 mm ²	65	ET.00.TKPC.CC14.3516	ET.00.TPP
35 mm ²	25 mm ²	65	ET.00.TKPC.CC14.3525	ET.00.TPP
50 mm ²	50 mm ²	90	ET.00.TKPC.CC14.50	ET.00.TPP
50 mm ²	16 mm ²	90	ET.00.TKPC.CC14.5016	ET.00.TPP
50 mm ²	25 mm ²	90	ET.00.TKPC.CC14.5025	ET.00.TPP
50 mm ²	35 mm ²	90	ET.00.TKPC.CC14.5035	ET.00.TPP
8.0 mm	8.0 mm	90	ET.00.TKPC.CC14.08	ET.00.TPP
8.0 mm	50 mm ²	90	ET.00.TKPC.CC14.0850	ET.00.TPP
70 mm ²	70 mm ²	115	ET.00.TKPC.CC14.70	ET.00.TPP
70 mm ²	50 mm ²	115	ET.00.TKPC.CC14.7050	ET.00.TPP
70 mm ²	35 mm ²	90	ET.00.TKPC.CC14.7035	ET.00.TPP
70 mm ²	25 mm ²	90	ET.00.TKPC.CC14.7025	ET.00.TPP
10.0 mm	10.0 mm	115	ET.00.TKPC.CC14.10	ET.00.TPP
95 mm ²	95 mm ²	150	ET.00.TKPC.CC14.95	ET.00.TPP
95 mm ²	70 mm ²	150	ET.00.TKPC.CC14.9570	ET.00.TPP
95 mm ²	50 mm ²	150	ET.00.TKPC.CC14.9550	ET.00.TPP
95 mm ²	35 mm ²	115	ET.00.TKPC.CC14.9535	ET.00.TPP
120 mm ²	120 mm ²	200	ET.00.TKPC.CC14.120	ET.00.TPP
120 mm ²	95 mm ²	200	ET.00.TKPC.CC14.12095	ET.00.TPP
120 mm ²	70 mm ²	200	ET.00.TKPC.CC14.12070	ET.00.TPP
120 mm ²	50 mm ²	150	ET.00.TKPC.CC14.12050	ET.00.TPP
150 mm ²	150 mm ²	250	ET.00.TKPD.CC14.150	ET.00.TPP
150 mm ²	120 mm ²	250	ET.00.TKPD.CC14.150120	ET.00.TPP
150 mm ²	95 mm ²	250	ET.00.TKPD.CC14.15095	ET.00.TPP
150 mm ²	70 mm ²	200	ET.00.TKPD.CC14.15070	ET.00.TPP
185 mm ²	185 mm ²	2x150	ET.00.TKPD.CC14.185	ET.00.TPP
185 mm ²	150 mm ²	2x150	ET.00.TKPD.CC14.185150	ET.00.TPP
185 mm ²	120 mm ²	250	ET.00.TKPD.CC14.185120	ET.00.TPP
185 mm ²	95 mm ²	250	ET.00.TKPD.CC14.18595	ET.00.TPP
240 mm ²	240 mm ²	2x200	ET.00.TKPD.CC14.240	ET.00.TPP
240 mm ²	185 mm ²	2x200	ET.00.TKPD.CC14.240185	ET.00.TPP
240 mm ²	150 mm ²	2x150	ET.00.TKPD.CC14.240150	ET.00.TPP
240 mm ²	120 mm ²	2x150	ET.00.TKPD.CC14.240120	ET.00.TPP

Kablodan Topraklama Elektroduna
Cable to Earth Rod

Elektrod Ölçüsü (a)	İletken Ölçüsü (b)	Kaynak Tozu (gr)	Pota	Pense Modeli
Rod Diameter (a)	Conductor Diameter (b)	Welding Powder (gr)	Mould	Handle Clamp
16.0 mm	16 mm ²	65	ET.00.TKPC.CE1.1616	ET.00.TPP
16.0 mm	25 mm ²	65	ET.00.TKPC.CE1.1625	ET.00.TPP
16.0 mm	35 mm ²	65	ET.00.TKPC.CE1.1635	ET.00.TPP
16.0 mm	50 mm ²	90	ET.00.TKPC.CE1.1650	ET.00.TPP
16.0 mm	8.0 mm	90	ET.00.TKPC.CE1.1608	ET.00.TPP
16.0 mm	70 mm ²	90	ET.00.TKPC.CE1.1670	ET.00.TPP
16.0 mm	10.0 mm	90	ET.00.TKPC.CE1.1610	ET.00.TPP
16.0 mm	95 mm ²	90	ET.00.TKPC.CE1.1695	ET.00.TPP
16.0 mm	120 mm ²	90	ET.00.TKPC.CE1.16120	ET.00.TPP
16.0 mm	150 mm ²	115	ET.00.TKPC.CE1.16150	ET.00.TPP
16.0 mm	185 mm ²	115	ET.00.TKPC.CE1.16185	ET.00.TPP
16.0 mm	240 mm ²	150	ET.00.TKPC.CE1.16240	ET.00.TPP
18.0 mm	16 mm ²	90	ET.00.TKPC.CE1.1816	ET.00.TPP
18.0 mm	25 mm ²	90	ET.00.TKPC.CE1.1825	ET.00.TPP
18.0 mm	35 mm ²	90	ET.00.TKPC.CE1.1835	ET.00.TPP
18.0 mm	50 mm ²	90	ET.00.TKPC.CE1.1850	ET.00.TPP
18.0 mm	8.0 mm	90	ET.00.TKPC.CE1.1808	ET.00.TPP
18.0 mm	70 mm ²	115	ET.00.TKPC.CE1.1870	ET.00.TPP
18.0 mm	10.0 mm	115	ET.00.TKPC.CE1.1810	ET.00.TPP
18.0 mm	95 mm ²	115	ET.00.TKPC.CE1.1895	ET.00.TPP
18.0 mm	120 mm ²	150	ET.00.TKPC.CE1.18120	ET.00.TPP
18.0 mm	150 mm ²	200	ET.00.TKPC.CE1.18150	ET.00.TPP
18.0 mm	185 mm ²	200	ET.00.TKPC.CE1.18185	ET.00.TPP
18.0 mm	240 mm ²	250	ET.00.TKPC.CE1.18240	ET.00.TPP
20.0 mm	16 mm ²	90	ET.00.TKPC.CE1.2016	ET.00.TPP
20.0 mm	25 mm ²	90	ET.00.TKPC.CE1.2025	ET.00.TPP
20.0 mm	35 mm ²	90	ET.00.TKPC.CE1.2035	ET.00.TPP
20.0 mm	50 mm ²	115	ET.00.TKPC.CE1.2050	ET.00.TPP
20.0 mm	8.0 mm	115	ET.00.TKPC.CE1.2008	ET.00.TPP
20.0 mm	70 mm ²	115	ET.00.TKPC.CE1.2070	ET.00.TPP
20.0 mm	10.0 mm	115	ET.00.TKPC.CE1.2010	ET.00.TPP
20.0 mm	95 mm ²	115	ET.00.TKPC.CE1.2095	ET.00.TPP
20.0 mm	120 mm ²	150	ET.00.TKPC.CE1.20120	ET.00.TPP
20.0 mm	150 mm ²	200	ET.00.TKPC.CE1.20150	ET.00.TPP
20.0 mm	185 mm ²	200	ET.00.TKPC.CE1.20185	ET.00.TPP
20.0 mm	240 mm ²	250	ET.00.TKPC.CE1.20240	ET.00.TPP

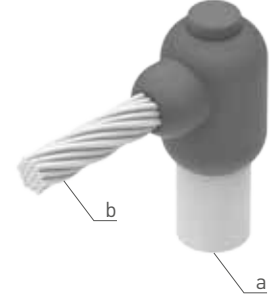

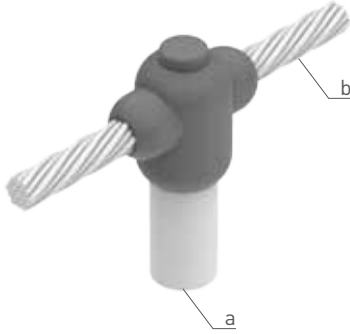
Kablodan Topraklama Elektroduna
 Cable to Earth Rod

Elektrod Ölçüsü (a)	İletken Ölçüsü (b)	Kaynak Tozu (gr)	Pota	Pense Modeli
Rod Diameter (a)	Conductor Diameter (b)	Welding Powder (gr)	Mould	Handle Clamp
16.0 mm	16 mm ²	65	ET.00.TKPC.CE2.1616	ET.00.TPP
16.0 mm	25 mm ²	65	ET.00.TKPC.CE2.1625	ET.00.TPP
16.0 mm	35 mm ²	65	ET.00.TKPC.CE2.1635	ET.00.TPP
16.0 mm	50 mm ²	90	ET.00.TKPC.CE2.1650	ET.00.TPP
16.0 mm	8.0 mm	90	ET.00.TKPC.CE2.1608	ET.00.TPP
16.0 mm	70 mm ²	90	ET.00.TKPC.CE2.1670	ET.00.TPP
16.0 mm	10.0 mm	90	ET.00.TKPC.CE2.1610	ET.00.TPP
16.0 mm	95 mm ²	90	ET.00.TKPC.CE2.1695	ET.00.TPP
16.0 mm	120 mm ²	90	ET.00.TKPC.CE2.16120	ET.00.TPP
16.0 mm	150 mm ²	115	ET.00.TKPC.CE2.16150	ET.00.TPP
16.0 mm	185 mm ²	115	ET.00.TKPC.CE2.16185	ET.00.TPP
16.0 mm	240 mm ²	150	ET.00.TKPC.CE2.16240	ET.00.TPP
18.0 mm	16 mm ²	90	ET.00.TKPC.CE2.1816	ET.00.TPP
18.0 mm	25 mm ²	90	ET.00.TKPC.CE2.1825	ET.00.TPP
18.0 mm	35 mm ²	90	ET.00.TKPC.CE2.1835	ET.00.TPP
18.0 mm	50 mm ²	90	ET.00.TKPC.CE2.1850	ET.00.TPP
18.0 mm	8.0 mm	90	ET.00.TKPC.CE2.1808	ET.00.TPP
18.0 mm	70 mm ²	115	ET.00.TKPC.CE2.1870	ET.00.TPP
18.0 mm	10.0 mm	115	ET.00.TKPC.CE2.1810	ET.00.TPP
18.0 mm	95 mm ²	115	ET.00.TKPC.CE2.1895	ET.00.TPP
18.0 mm	120 mm ²	150	ET.00.TKPC.CE2.18120	ET.00.TPP
18.0 mm	150 mm ²	200	ET.00.TKPC.CE2.18150	ET.00.TPP
18.0 mm	185 mm ²	200	ET.00.TKPC.CE2.18185	ET.00.TPP
18.0 mm	240 mm ²	250	ET.00.TKPC.CE2.18240	ET.00.TPP
20.0 mm	16 mm ²	90	ET.00.TKPC.CE2.2016	ET.00.TPP
20.0 mm	25 mm ²	90	ET.00.TKPC.CE2.2025	ET.00.TPP
20.0 mm	35 mm ²	90	ET.00.TKPC.CE2.2035	ET.00.TPP
20.0 mm	50 mm ²	115	ET.00.TKPC.CE2.2050	ET.00.TPP
20.0 mm	8.0 mm	115	ET.00.TKPC.CE2.2008	ET.00.TPP
20.0 mm	70 mm ²	115	ET.00.TKPC.CE2.2070	ET.00.TPP
20.0 mm	10.0 mm	115	ET.00.TKPC.CE2.2010	ET.00.TPP
20.0 mm	95 mm ²	115	ET.00.TKPC.CE2.2095	ET.00.TPP
20.0 mm	120 mm ²	150	ET.00.TKPC.CE2.20120	ET.00.TPP
20.0 mm	150 mm ²	200	ET.00.TKPC.CE2.20150	ET.00.TPP
20.0 mm	185 mm ²	200	ET.00.TKPC.CE2.20185	ET.00.TPP
20.0 mm	240 mm ²	250	ET.00.TKPC.CE2.20240	ET.00.TPP

Kablodan Topraklama Elektroduna
Cable to Earth Rod

Elektrod Ölçüsü (a)	İletken Ölçüsü (b)	Kaynak Tozu (gr)	Pota	Pense Modeli
Rod Diameter (a)	Conductor Diameter (b)	Welding Powder (gr)	Mould	Handle Clamp
16.0 mm	16 mm ²	90	ET.00.TKPE.CE3.1616	ET.00.TPPB
16.0 mm	25 mm ²	90	ET.00.TKPE.CE3.1625	ET.00.TPPB
16.0 mm	35 mm ²	90	ET.00.TKPE.CE3.1635	ET.00.TPPB
16.0 mm	50 mm ²	115	ET.00.TKPE.CE3.1650	ET.00.TPPB
16.0 mm	8.0 mm	115	ET.00.TKPE.CE3.1608	ET.00.TPPB
16.0 mm	70 mm ²	200	ET.00.TKPE.CE3.1670	ET.00.TPPB
16.0 mm	10.0 mm	150	ET.00.TKPE.CE3.1610	ET.00.TPPB
16.0 mm	95 mm ²	250	ET.00.TKPE.CE3.1695	ET.00.TPPB
16.0 mm	120 mm ²	250	ET.00.TKPE.CE3.16120	ET.00.TPPB
16.0 mm	150 mm ²	250	ET.00.TKPE.CE3.16150	ET.00.TPPB
16.0 mm	185 mm ²	2x150	ET.00.TKPE.CE3.16185	ET.00.TPPB
16.0 mm	240 mm ²	2x200	ET.00.TKPE.CE3.16240	ET.00.TPPB
18.0 mm	16 mm ²	90	ET.00.TKPE.CE3.1816	ET.00.TPPB
18.0 mm	25 mm ²	90	ET.00.TKPE.CE3.1825	ET.00.TPPB
18.0 mm	35 mm ²	90	ET.00.TKPE.CE3.1835	ET.00.TPPB
18.0 mm	50 mm ²	115	ET.00.TKPE.CE3.1850	ET.00.TPPB
18.0 mm	8.0 mm	115	ET.00.TKPE.CE3.1808	ET.00.TPPB
18.0 mm	70 mm ²	200	ET.00.TKPE.CE3.1870	ET.00.TPPB
18.0 mm	10.0 mm	150	ET.00.TKPE.CE3.1810	ET.00.TPPB
18.0 mm	95 mm ²	250	ET.00.TKPE.CE3.1895	ET.00.TPPB
18.0 mm	120 mm ²	250	ET.00.TKPE.CE3.18120	ET.00.TPPB
18.0 mm	150 mm ²	250	ET.00.TKPE.CE3.18150	ET.00.TPPB
18.0 mm	185 mm ²	2x150	ET.00.TKPE.CE3.18185	ET.00.TPPB
18.0 mm	240 mm ²	2x200	ET.00.TKPE.CE3.18240	ET.00.TPPB
20.0 mm	16 mm ²	90	ET.00.TKPE.CE3.2016	ET.00.TPPB
20.0 mm	25 mm ²	90	ET.00.TKPE.CE3.2025	ET.00.TPPB
20.0 mm	35 mm ²	90	ET.00.TKPE.CE3.2035	ET.00.TPPB
20.0 mm	50 mm ²	115	ET.00.TKPE.CE3.2050	ET.00.TPPB
20.0 mm	8.0 mm	115	ET.00.TKPE.CE3.2008	ET.00.TPPB
20.0 mm	70 mm ²	200	ET.00.TKPE.CE3.2070	ET.00.TPPB
20.0 mm	10.0 mm	150	ET.00.TKPE.CE3.2010	ET.00.TPPB
20.0 mm	95 mm ²	250	ET.00.TKPE.CE3.2095	ET.00.TPPB
20.0 mm	120 mm ²	250	ET.00.TKPE.CE3.20120	ET.00.TPPB
20.0 mm	150 mm ²	250	ET.00.TKPE.CE3.20150	ET.00.TPPB
20.0 mm	185 mm ²	2x150	ET.00.TKPE.CE3.20185	ET.00.TPPB
20.0 mm	240 mm ²	2x200	ET.00.TKPE.CE3.20240	ET.00.TPPB

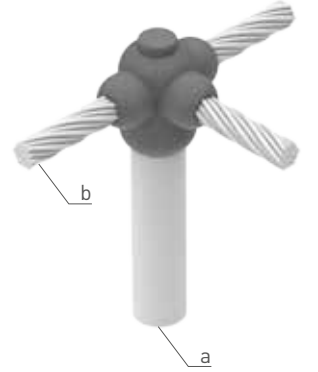

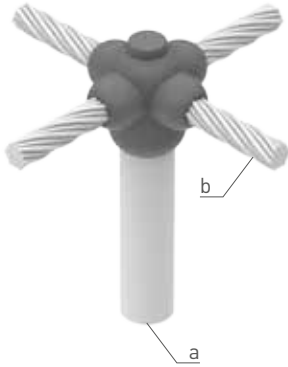
Kablodan Topraklama Elektroduna
Cable to Earth Rod

Elektrod Ölçüsü (a)	İletken Ölçüsü (b)	Kaynak Tozu (gr)	Pota	Pense Modeli
Rod Diameter (a)	Conductor Diameter (b)	Welding Powder (gr)	Mould	Handle Clamp
16.0 mm	16 mm ²	115	ET.00.TKPE.CE4.1616	ET.00.TPPB
16.0 mm	25 mm ²	150	ET.00.TKPE.CE4.1625	ET.00.TPPB
16.0 mm	35 mm ²	150	ET.00.TKPE.CE4.1635	ET.00.TPPB
16.0 mm	50 mm ²	200	ET.00.TKPE.CE4.1650	ET.00.TPPB
16.0 mm	8.0 mm	200	ET.00.TKPE.CE4.1608	ET.00.TPPB
16.0 mm	70 mm ²	250	ET.00.TKPE.CE4.1670	ET.00.TPPB
16.0 mm	10.0 mm	250	ET.00.TKPE.CE4.1610	ET.00.TPPB
16.0 mm	95 mm ²	2x150	ET.00.TKPE.CE4.1695	ET.00.TPPB
16.0 mm	120 mm ²	2x150	ET.00.TKPE.CE4.16120	ET.00.TPPB
16.0 mm	150 mm ²	2x200	ET.00.TKPE.CE4.16150	ET.00.TPPB
16.0 mm	185 mm ²	2x200	ET.00.TKPE.CE4.16185	ET.00.TPPB
16.0 mm	240 mm ²	2x250	ET.00.TKPE.CE4.16240	ET.00.TPPB
18.0 mm	16 mm ²	115	ET.00.TKPE.CE4.1816	ET.00.TPPB
18.0 mm	25 mm ²	150	ET.00.TKPE.CE4.1825	ET.00.TPPB
18.0 mm	35 mm ²	150	ET.00.TKPE.CE4.1835	ET.00.TPPB
18.0 mm	50 mm ²	200	ET.00.TKPE.CE4.1850	ET.00.TPPB
18.0 mm	8.0 mm	200	ET.00.TKPE.CE4.1808	ET.00.TPPB
18.0 mm	70 mm ²	250	ET.00.TKPE.CE4.1870	ET.00.TPPB
18.0 mm	10.0 mm	250	ET.00.TKPE.CE4.1810	ET.00.TPPB
18.0 mm	95 mm ²	2x150	ET.00.TKPE.CE4.1895	ET.00.TPPB
18.0 mm	120 mm ²	2x150	ET.00.TKPE.CE4.18120	ET.00.TPPB
18.0 mm	150 mm ²	2x200	ET.00.TKPE.CE4.18150	ET.00.TPPB
18.0 mm	185 mm ²	2x200	ET.00.TKPE.CE4.18185	ET.00.TPPB
18.0 mm	240 mm ²	2x250	ET.00.TKPE.CE4.18240	ET.00.TPPB
20.0 mm	16 mm ²	115	ET.00.TKPE.CE4.2016	ET.00.TPPB
20.0 mm	25 mm ²	150	ET.00.TKPE.CE4.2025	ET.00.TPPB
20.0 mm	35 mm ²	150	ET.00.TKPE.CE4.2035	ET.00.TPPB
20.0 mm	50 mm ²	200	ET.00.TKPE.CE4.2050	ET.00.TPPB
20.0 mm	8.0 mm	200	ET.00.TKPE.CE4.2008	ET.00.TPPB
20.0 mm	70 mm ²	250	ET.00.TKPE.CE4.2070	ET.00.TPPB
20.0 mm	10.0 mm	250	ET.00.TKPE.CE4.2010	ET.00.TPPB
20.0 mm	95 mm ²	2x150	ET.00.TKPE.CE4.2095	ET.00.TPPB
20.0 mm	120 mm ²	2x150	ET.00.TKPE.CE4.20120	ET.00.TPPB
20.0 mm	150 mm ²	2x200	ET.00.TKPE.CE4.20150	ET.00.TPPB
20.0 mm	185 mm ²	2x200	ET.00.TKPE.CE4.20185	ET.00.TPPB
20.0 mm	240 mm ²	2x250	ET.00.TKPE.CE4.20240	ET.00.TPPB

Kablodan Topraklama Elektroduna
Cable to Earth Rod

Elektrod Ölçüsü (a)	İletken Ölçüsü (b)	Kaynak Tozu (gr)	Pota	Pense Modeli
Rod Diameter (a)	Conductor Diameter (b)	Welding Powder (gr)	Mould	Handle Clamp
16.0 mm	16 mm ²	90	ET.00.TKPC.CE17.1616	ET.00.TPP
16.0 mm	25 mm ²	90	ET.00.TKPC.CE17.1625	ET.00.TPP
16.0 mm	35 mm ²	90	ET.00.TKPC.CE17.1635	ET.00.TPP
16.0 mm	50 mm ²	115	ET.00.TKPC.CE17.1650	ET.00.TPP
16.0 mm	8.0 mm	115	ET.00.TKPC.CE17.1608	ET.00.TPP
16.0 mm	70 mm ²	200	ET.00.TKPC.CE17.1670	ET.00.TPP
16.0 mm	10.0 mm	200	ET.00.TKPC.CE17.1610	ET.00.TPP
16.0 mm	95 mm ²	250	ET.00.TKPC.CE17.1695	ET.00.TPP
16.0 mm	120 mm ²	250	ET.00.TKPC.CE17.16120	ET.00.TPP
16.0 mm	150 mm ²	250	ET.00.TKPC.CE17.16150	ET.00.TPP
16.0 mm	185 mm ²	2x150	ET.00.TKPC.CE17.16185	ET.00.TPP
16.0 mm	240 mm ²	2x200	ET.00.TKPC.CE17.16240	ET.00.TPP
18.0 mm	16 mm ²	115	ET.00.TKPC.CE17.1816	ET.00.TPP
18.0 mm	25 mm ²	115	ET.00.TKPC.CE17.1825	ET.00.TPP
18.0 mm	35 mm ²	115	ET.00.TKPC.CE17.1835	ET.00.TPP
18.0 mm	50 mm ²	150	ET.00.TKPC.CE17.1850	ET.00.TPP
18.0 mm	8.0 mm	150	ET.00.TKPC.CE17.1808	ET.00.TPP
18.0 mm	70 mm ²	200	ET.00.TKPC.CE17.1870	ET.00.TPP
18.0 mm	10.0 mm	250	ET.00.TKPC.CE17.1810	ET.00.TPP
18.0 mm	95 mm ²	250	ET.00.TKPC.CE17.1895	ET.00.TPP
18.0 mm	120 mm ²	250	ET.00.TKPC.CE17.18120	ET.00.TPP
18.0 mm	150 mm ²	2x150	ET.00.TKPC.CE17.18150	ET.00.TPP
18.0 mm	185 mm ²	2x150	ET.00.TKPC.CE17.18185	ET.00.TPP
18.0 mm	240 mm ²	2x200	ET.00.TKPC.CE17.18240	ET.00.TPP
20.0 mm	16 mm ²	115	ET.00.TKPC.CE17.2016	ET.00.TPP
20.0 mm	25 mm ²	115	ET.00.TKPC.CE17.2025	ET.00.TPP
20.0 mm	35 mm ²	115	ET.00.TKPC.CE17.2035	ET.00.TPP
20.0 mm	50 mm ²	150	ET.00.TKPC.CE17.2050	ET.00.TPP
20.0 mm	8.0 mm	150	ET.00.TKPC.CE17.2008	ET.00.TPP
20.0 mm	70 mm ²	200	ET.00.TKPC.CE17.2070	ET.00.TPP
20.0 mm	10.0 mm	250	ET.00.TKPC.CE17.2010	ET.00.TPP
20.0 mm	95 mm ²	250	ET.00.TKPC.CE17.2095	ET.00.TPP
20.0 mm	120 mm ²	250	ET.00.TKPC.CE17.20120	ET.00.TPP
20.0 mm	150 mm ²	2x150	ET.00.TKPC.CE17.20150	ET.00.TPP
20.0 mm	185 mm ²	2x150	ET.00.TKPC.CE17.20185	ET.00.TPP
20.0 mm	240 mm ²	2x200	ET.00.TKPC.CE17.20240	ET.00.TPP

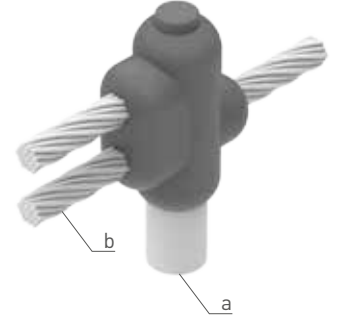

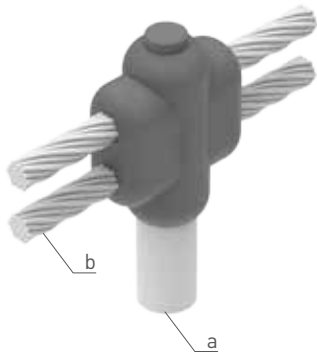
Kablodan Topraklama Elektroduna
 Cable to Earth Rod

Elektrod Ölçüsü (a)	İletken Ölçüsü (b)	Kaynak Tozu (gr)	Pota	Pense Modeli
Rod Diameter (a)	Conductor Diameter (b)	Welding Powder (gr)	Mould	Handle Clamp
16.0 mm	16 mm ²	115	ET.00.TKPC.CE24.1616	ET.00.TPP
16.0 mm	25 mm ²	115	ET.00.TKPC.CE24.1625	ET.00.TPP
16.0 mm	35 mm ²	115	ET.00.TKPC.CE24.1635	ET.00.TPP
16.0 mm	50 mm ²	200	ET.00.TKPC.CE24.1650	ET.00.TPP
16.0 mm	8.0 mm	200	ET.00.TKPC.CE24.1608	ET.00.TPP
16.0 mm	70 mm ²	250	ET.00.TKPC.CE24.1670	ET.00.TPP
16.0 mm	10.0 mm	250	ET.00.TKPC.CE24.1610	ET.00.TPP
16.0 mm	95 mm ²	250	ET.00.TKPC.CE24.1695	ET.00.TPP
16.0 mm	120 mm ²	2x150	ET.00.TKPC.CE24.16120	ET.00.TPP
16.0 mm	150 mm ²	2x150	ET.00.TKPC.CE24.16150	ET.00.TPP
16.0 mm	185 mm ²	2x200	ET.00.TKPC.CE24.16185	ET.00.TPP
16.0 mm	240 mm ²	2x200	ET.00.TKPC.CE24.16240	ET.00.TPP
18.0 mm	16 mm ²	115	ET.00.TKPC.CE24.1816	ET.00.TPP
18.0 mm	25 mm ²	115	ET.00.TKPC.CE24.1825	ET.00.TPP
18.0 mm	35 mm ²	115	ET.00.TKPC.CE24.1835	ET.00.TPP
18.0 mm	50 mm ²	250	ET.00.TKPC.CE24.1850	ET.00.TPP
18.0 mm	8.0 mm	250	ET.00.TKPC.CE24.1808	ET.00.TPP
18.0 mm	70 mm ²	2x150	ET.00.TKPC.CE24.1870	ET.00.TPP
18.0 mm	10.0 mm	2x150	ET.00.TKPC.CE24.1810	ET.00.TPP
18.0 mm	95 mm ²	2x150	ET.00.TKPC.CE24.1895	ET.00.TPP
18.0 mm	120 mm ²	2x150	ET.00.TKPC.CE24.18120	ET.00.TPP
18.0 mm	150 mm ²	2x200	ET.00.TKPC.CE24.18150	ET.00.TPP
18.0 mm	185 mm ²	2x200	ET.00.TKPC.CE24.18185	ET.00.TPP
18.0 mm	240 mm ²	2x250	ET.00.TKPC.CE24.18240	ET.00.TPP
20.0 mm	16 mm ²	115	ET.00.TKPC.CE24.2016	ET.00.TPP
20.0 mm	25 mm ²	115	ET.00.TKPC.CE24.2025	ET.00.TPP
20.0 mm	35 mm ²	115	ET.00.TKPC.CE24.2035	ET.00.TPP
20.0 mm	50 mm ²	250	ET.00.TKPC.CE24.2050	ET.00.TPP
20.0 mm	8.0 mm	250	ET.00.TKPC.CE24.2008	ET.00.TPP
20.0 mm	70 mm ²	2x150	ET.00.TKPC.CE24.2070	ET.00.TPP
20.0 mm	10.0 mm	2x150	ET.00.TKPC.CE24.2010	ET.00.TPP
20.0 mm	95 mm ²	2x150	ET.00.TKPC.CE24.2095	ET.00.TPP
20.0 mm	120 mm ²	2x150	ET.00.TKPC.CE24.20120	ET.00.TPP
20.0 mm	150 mm ²	2x200	ET.00.TKPC.CE24.20150	ET.00.TPP
20.0 mm	185 mm ²	2x200	ET.00.TKPC.CE24.20185	ET.00.TPP
20.0 mm	240 mm ²	2x250	ET.00.TKPC.CE24.20240	ET.00.TPP

Kablodan İnşaat Demirine

Cable to Reinforcing Bar

Demir Ölçüsü (a)	İletken Ölçüsü (b)	Kaynak Tozu (gr)	Pota	Pense Modeli
Rebar Diameter (a)	Conductor Diameter (b)	Welding Powder (gr)	Mould	Handle Clamp
18.0 mm	16 mm ²	115	ET.00.TKPC.CR2.1816	ET.00.TPP
18.0 mm	25 mm ²	115	ET.00.TKPC.CR2.1825	ET.00.TPP
18.0 mm	35 mm ²	115	ET.00.TKPC.CR2.1835	ET.00.TPP
18.0 mm	50 mm ²	150	ET.00.TKPC.CR2.1850	ET.00.TPP
18.0 mm	8.0 mm	150	ET.00.TKPC.CR2.1808	ET.00.TPP
18.0 mm	70 mm ²	150	ET.00.TKPC.CR2.1870	ET.00.TPP
18.0 mm	10.0 mm	150	ET.00.TKPC.CR2.1810	ET.00.TPP
18.0 mm	95 mm ²	150	ET.00.TKPC.CR2.1895	ET.00.TPP
18.0 mm	120 mm ²	200	ET.00.TKPC.CR2.18120	ET.00.TPP
20.0 mm	16 mm ²	115	ET.00.TKPC.CR2.2016	ET.00.TPP
20.0 mm	25 mm ²	115	ET.00.TKPC.CR2.2025	ET.00.TPP
20.0 mm	35 mm ²	115	ET.00.TKPC.CR2.2035	ET.00.TPP
20.0 mm	50 mm ²	150	ET.00.TKPC.CR2.2050	ET.00.TPP
20.0 mm	8.0 mm	150	ET.00.TKPC.CR2.2008	ET.00.TPP
20.0 mm	70 mm ²	200	ET.00.TKPC.CR2.2070	ET.00.TPP
20.0 mm	10.0 mm	150	ET.00.TKPC.CR2.2010	ET.00.TPP
20.0 mm	95 mm ²	200	ET.00.TKPC.CR2.2095	ET.00.TPP
20.0 mm	120 mm ²	200	ET.00.TKPC.CR2.20120	ET.00.TPP
26.0 mm	16 mm ²	200	ET.00.TKPC.CR2.2616	ET.00.TPP
26.0 mm	25 mm ²	200	ET.00.TKPC.CR2.2625	ET.00.TPP
26.0 mm	35 mm ²	200	ET.00.TKPC.CR2.2635	ET.00.TPP
26.0 mm	50 mm ²	200	ET.00.TKPC.CR2.2650	ET.00.TPP
26.0 mm	8.0 mm	200	ET.00.TKPC.CR2.2608	ET.00.TPP
26.0 mm	70 mm ²	250	ET.00.TKPC.CR2.2670	ET.00.TPP
26.0 mm	10.0 mm	250	ET.00.TKPC.CR2.2610	ET.00.TPP
26.0 mm	95 mm ²	250	ET.00.TKPC.CR2.2695	ET.00.TPP
26.0 mm	120 mm ²	250	ET.00.TKPC.CR2.26120	ET.00.TPP
32.0 mm	16 mm ²	250	ET.00.TKPC.CR2.3216	ET.00.TPP
32.0 mm	25 mm ²	250	ET.00.TKPC.CR2.3225	ET.00.TPP
32.0 mm	35 mm ²	250	ET.00.TKPC.CR2.3235	ET.00.TPP
32.0 mm	50 mm ²	2x150	ET.00.TKPC.CR2.3250	ET.00.TPP
32.0 mm	8.0 mm	2x150	ET.00.TKPC.CR2.3208	ET.00.TPP
32.0 mm	70 mm ²	2x150	ET.00.TKPC.CR2.3270	ET.00.TPP
32.0 mm	10.0 mm	2x150	ET.00.TKPC.CR2.3210	ET.00.TPP
32.0 mm	95 mm ²	2x150	ET.00.TKPC.CR2.3295	ET.00.TPP
32.0 mm	120 mm ²	2x200	ET.00.TKPC.CR2.32120	ET.00.TPP

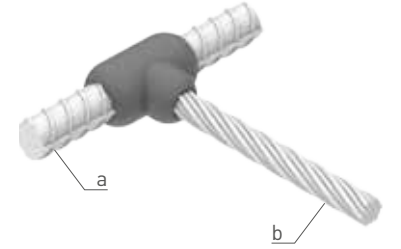

Kablodan İnşaat Demirine

Cable to Reinforcing Bar

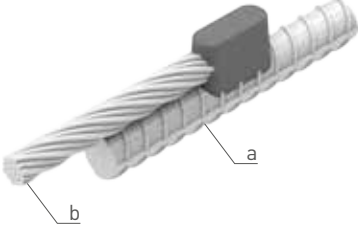

Demir Ölçüsü (a)	İletken Ölçüsü (b)	Kayna Tozu (gr)	Pota	Pense Modeli
Rebar Diameter (a)	Conductor Diameter (b)	Welding Powder (gr)	Mould	Handle Clamp
10 - 40.0 mm	16 mm ²	45	ET.00.TKPC.CR1.16	ET.00.TPP
10 - 40.0 mm	25 mm ²	45	ET.00.TKPC.CR1.25	ET.00.TPP
10 - 40.0 mm	35 mm ²	45	ET.00.TKPC.CR1.35	ET.00.TPP
10 - 40.0 mm	50 mm ²	90	ET.00.TKPC.CR1.50	ET.00.TPP
10 - 40.0 mm	8.0 mm	90	ET.00.TKPC.CR1.08	ET.00.TPP
10 - 40.0 mm	70 mm ²	90	ET.00.TKPC.CR1.70	ET.00.TPP
10 - 40.0 mm	10.0 mm	90	ET.00.TKPC.CR1.10	ET.00.TPP
10 - 40.0 mm	95 mm ²	90	ET.00.TKPC.CR1.95	ET.00.TPP
10 - 40.0 mm	120 mm ²	90	ET.00.TKPC.CR1.120	ET.00.TPP

Kablodan İnşaat Demirine

Cable to Reinforcing Bar

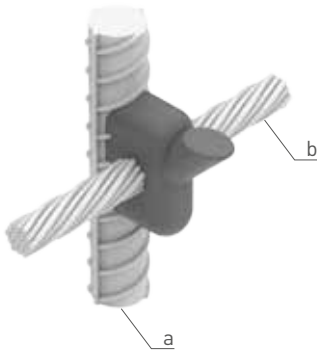

Demir Ölçüsü (a)	İletken Ölçüsü (b)	Kaynak Tozu (gr)	Pota	Pense Modeli
Rebar Diameter (a)	Conductor Diameter (b)	Welding Powder (gr)	Mould	Handle Clamp
10 - 40.0 mm	16 mm ²	45	ET.00.TKPC.CR3.16	ET.00.TPP
10 - 40.0 mm	25 mm ²	45	ET.00.TKPC.CR3.25	ET.00.TPP
10 - 40.0 mm	35 mm ²	45	ET.00.TKPC.CR3.35	ET.00.TPP
10 - 40.0 mm	50 mm ²	90	ET.00.TKPC.CR3.50	ET.00.TPP
10 - 40.0 mm	8.0 mm	90	ET.00.TKPC.CR3.08	ET.00.TPP
10 - 40.0 mm	70 mm ²	90	ET.00.TKPC.CR3.70	ET.00.TPP
10 - 40.0 mm	10.0 mm	90	ET.00.TKPC.CR3.10	ET.00.TPP
10 - 40.0 mm	95 mm ²	90	ET.00.TKPC.CR3.95	ET.00.TPP
10 - 40.0 mm	120 mm ²	90	ET.00.TKPC.CR3.120	ET.00.TPP

Kablodan İnşaat Demirine

Cable to Reinforcing Bar

Demir Ölçüsü (a)	İletken Ölçüsü (b)	Kaynak Tozu (gr)	Pota	Pense Modeli
Rebar Diameter (a)	Conductor Diameter (b)	Welding Powder (gr)	Mould	Handle Clamp
10 - 40.0 mm	16 mm ²	45	ET.00.TKPC.CR6.16	ET.00.TPP
10 - 40.0 mm	25 mm ²	45	ET.00.TKPC.CR6.25	ET.00.TPP
10 - 40.0 mm	35 mm ²	45	ET.00.TKPC.CR6.35	ET.00.TPP
10 - 40.0 mm	50 mm ²	65	ET.00.TKPC.CR6.50	ET.00.TPP
10 - 40.0 mm	8.0 mm	65	ET.00.TKPC.CR6.08	ET.00.TPP
10 - 40.0 mm	70 mm ²	90	ET.00.TKPC.CR6.70	ET.00.TPP
10 - 40.0 mm	10.0 mm	90	ET.00.TKPC.CR6.10	ET.00.TPP
10 - 40.0 mm	95 mm ²	90	ET.00.TKPC.CR6.95	ET.00.TPP
10 - 40.0 mm	120 mm ²	115	ET.00.TKPC.CR6.120	ET.00.TPP

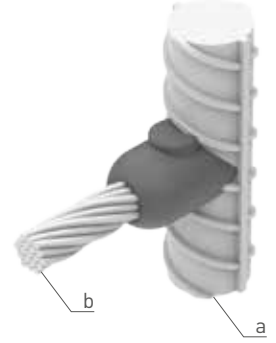

Kablodan İnşaat Demirine

Cable to Reinforcing Bar

Demir Ölçüsü (a)	İletken Ölçüsü (b)	Kaynak Tozu (gr)	Pota	Pense Modeli
Rebar Diameter (a)	Conductor Diameter (b)	Welding Powder (gr)	Mould	Handle Clamp
10 - 40.0 mm	16 mm ²	45	ET.00.TKPC.CR17.16	ET.00.TPP
10 - 40.0 mm	25 mm ²	45	ET.00.TKPC.CR17.25	ET.00.TPP
10 - 40.0 mm	35 mm ²	45	ET.00.TKPC.CR17.35	ET.00.TPP
10 - 40.0 mm	50 mm ²	90	ET.00.TKPC.CR17.50	ET.00.TPP
10 - 40.0 mm	8.0 mm	90	ET.00.TKPC.CR17.08	ET.00.TPP
10 - 40.0 mm	70 mm ²	90	ET.00.TKPC.CR17.70	ET.00.TPP
10 - 40.0 mm	10.0 mm	90	ET.00.TKPC.CR17.10	ET.00.TPP
10 - 40.0 mm	95 mm ²	90	ET.00.TKPC.CR17.95	ET.00.TPP
10 - 40.0 mm	120 mm ²	90	ET.00.TKPC.CR17.120	ET.00.TPP

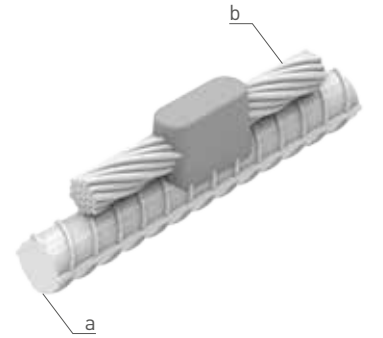

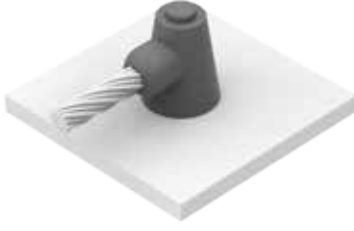
Kablodan Çelik Yüzeğe
 Cable to Steel Surface

İletken Ölçüsü	Kaynak Tozu (gr)	Pota	Pense Modeli
Conductor Diameter	Welding Powder (gr)	Mould	Handle Clamp
16 mm ²	65	ET.00.TKPC.CS1.16	ET.00.TPP
25 mm ²	65	ET.00.TKPC.CS1.25	ET.00.TPP
35 mm ²	65	ET.00.TKPC.CS1.35	ET.00.TPP
50 mm ²	90	ET.00.TKPC.CS1.50	ET.00.TPP
8.0 mm	90	ET.00.TKPC.CS1.08	ET.00.TPP
70 mm ²	90	ET.00.TKPC.CS1.70	ET.00.TPP
10.0 mm	90	ET.00.TKPC.CS1.10	ET.00.TPP
95 mm ²	115	ET.00.TKPC.CS1.95	ET.00.TPP
120 mm ²	115	ET.00.TKPC.CS1.120	ET.00.TPP
150 mm ²	150	ET.00.TKPC.CS1.150	ET.00.TPP
185 mm ²	200	ET.00.TKPC.CS1.185	ET.00.TPP
240 mm ²	200	ET.00.TKPC.CS1.240	ET.00.TPP
300 mm ²	250	ET.00.TKPC.CS1.300	ET.00.TPP

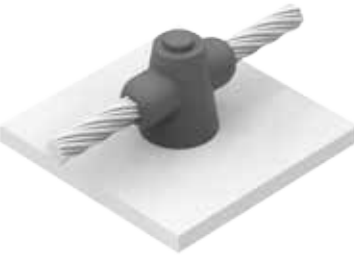
Kablodan Çelik Yüzeğe
 Cable to Steel Surface

İletken Ölçüsü	Kaynak Tozu (gr)	Pota	Pense Modeli
Conductor Diameter	Welding Powder (gr)	Mould	Handle Clamp
16 mm ²	65	ET.00.TKPC.CS2.16	ET.00.TPP
25 mm ²	65	ET.00.TKPC.CS2.25	ET.00.TPP
35 mm ²	65	ET.00.TKPC.CS2.35	ET.00.TPP
50 mm ²	90	ET.00.TKPC.CS2.50	ET.00.TPP
8.0 mm	90	ET.00.TKPC.CS2.08	ET.00.TPP
70 mm ²	90	ET.00.TKPC.CS2.70	ET.00.TPP
10.0 mm	90	ET.00.TKPC.CS2.10	ET.00.TPP
95 mm ²	115	ET.00.TKPC.CS2.95	ET.00.TPP
120 mm ²	115	ET.00.TKPC.CS2.120	ET.00.TPP
150 mm ²	150	ET.00.TKPC.CS2.150	ET.00.TPP
185 mm ²	200	ET.00.TKPC.CS2.185	ET.00.TPP
240 mm ²	200	ET.00.TKPC.CS2.240	ET.00.TPP
300 mm ²	250	ET.00.TKPC.CS2.300	ET.00.TPP

Kablodan Çelik Yüzeğe

Cable to Steel Surface

İletken Ölçüsü	Kaynak Tozu (gr)	Pota	Pense Modeli
Conductor Diameter	Welding Powder (gr)	Mould	Handle Clamp
16 mm ²	45	ET.00.TKPC.CS3.16	ET.00.TPP
25 mm ²	45	ET.00.TKPC.CS3.25	ET.00.TPP
35 mm ²	45	ET.00.TKPC.CS3.35	ET.00.TPP
50 mm ²	65	ET.00.TKPC.CS3.50	ET.00.TPP
8.0 mm	65	ET.00.TKPC.CS3.08	ET.00.TPP
70 mm ²	90	ET.00.TKPC.CS3.70	ET.00.TPP
10.0 mm	90	ET.00.TKPC.CS3.10	ET.00.TPP
95 mm ²	115	ET.00.TKPC.CS3.95	ET.00.TPP
120 mm ²	115	ET.00.TKPC.CS3.120	ET.00.TPP
150 mm ²	115	ET.00.TKPC.CS3.150	ET.00.TPP
185 mm ²	200	ET.00.TKPC.CS3.185	ET.00.TPP
240 mm ²	200	ET.00.TKPC.CS3.240	ET.00.TPP
300 mm ²	250	ET.00.TKPC.CS3.300	ET.00.TPP



Kablodan Çelik Yüzeğe

Cable to Steel Surface

İletken Ölçüsü	Kaynak Tozu (gr)	Pota	Pense Modeli
Conductor Diameter	Welding Powder (gr)	Mould	Handle Clamp
16 mm ²	65	ET.00.TKPD.CS7.16	ET.00.TPP
25 mm ²	65	ET.00.TKPD.CS7.25	ET.00.TPP
35 mm ²	65	ET.00.TKPD.CS7.35	ET.00.TPP
50 mm ²	90	ET.00.TKPD.CS7.50	ET.00.TPP
8.0 mm	90	ET.00.TKPD.CS7.08	ET.00.TPP
70 mm ²	150	ET.00.TKPD.CS7.70	ET.00.TPP
10.0 mm	150	ET.00.TKPD.CS7.10	ET.00.TPP
95 mm ²	200	ET.00.TKPD.CS7.95	ET.00.TPP
120 mm ²	200	ET.00.TKPD.CS7.120	ET.00.TPP
150 mm ²	250	ET.00.TKPD.CS7.150	ET.00.TPP
185 mm ²	2x150	ET.00.TKPD.CS7.185	ET.00.TPP
240 mm ²	2x150	ET.00.TKPD.CS7.240	ET.00.TPP
300 mm ²	2x200	ET.00.TKPD.CS7.300	ET.00.TPP



Pota
Mould

Ürün Kodu	Ağırlık (Ad)
Part No.	Weight (each)
ET.00.TKPB	1,60
ET.00.TKPC	1,40
ET.00.TKPD	2,40
ET.00.TKPE	2,40

Pota Pensesi
Handle Clamps

Ürün Kodu	Ağırlık (Ad)
Part No.	Weight (each)
ET.00.TPP	1,18
ET.00.TPPB	1,24

Pota Çakmağı
Flint Gun

Ürün Kodu	Ağırlık (Ad)
Part No.	Weight (each)
ET.00.TPC	0,11

Pota Fırçası
Mould Cleaning Brush

Ürün Kodu	Ağırlık (Ad)
Part No.	Weight (each)
ET.00.TPF	0,10

Pota Kazıyıcısı

Mould Cleaning Scraper

Ürün Kodu	Ağırlık (Ad)
Part No.	Weight (each)
ET.00.TPK	0,08



Pota Macunu

Mould Paste

Ürün Kodu	Ağırlık (Ad)
Part No.	Weight (each)
ET.00.TPM	1,00



Kaynak Tozu

Welding Powder

Ürün Kodu	Ağırlık (Ad)
Part No.	Weight (each)
ET.00.TKT.32	0,04
ET.00.TKT.45	0,05
ET.00.TKT.65	0,07
ET.00.TKT.90	0,10
ET.00.TKT.115	0,12
ET.00.TKT.150	0,16
ET.00.TKT.200	0,22
ET.00.TKT.250	0,27

