

Wire Mesh Cable Trays

metakson

metakson

Wire Mesh Cable Trays

Connectors

Birleştirme Elemanları

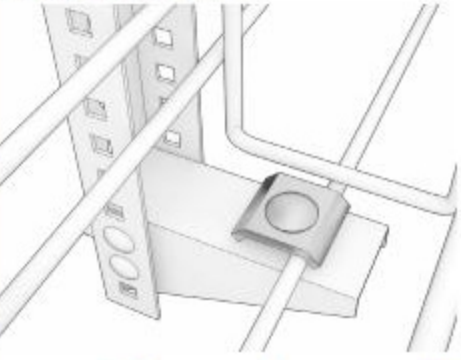

Fixing Unit -TSE

Sabitleme Elemanları -TSE



Model Number	Size (W) (mm)	Plate Thick. (T) (mm)	Weight kg/m	In pack, pc	Order Code (EG)	Order Code (HDG)	Order Code (SS)
U 25	25	2,5	1,41	200	1802 00 020 20 7	1802 00 020 20 2	1802 00 020 20 4
C M6	M6x20		1,3	250	9005 06 020 00 7	9005 06 020 00 2	9005 06 020 00 4
FS M6	M6		1,45	500	9002 06 000 00 7	9002 06 000 00 2	9002 06 000 00 4

Calculation of fixing units

Width (W)	set / bracket
50	1
100	1
150	1
200	2
250	2
300	2
400	2
500	2
600	2

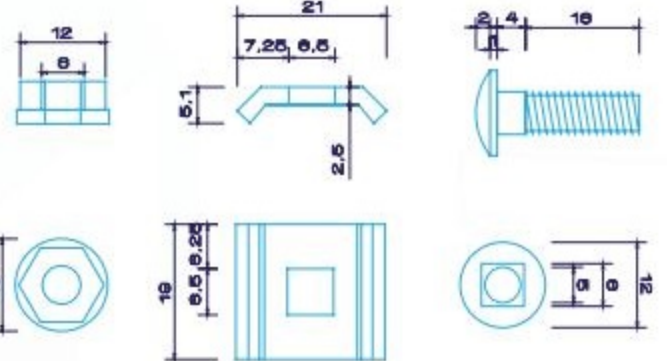

Connectors

Birleştirme Elemanları

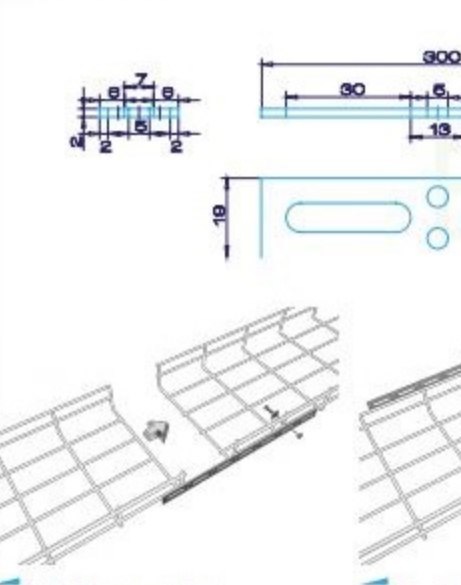

Multipurpose Connection Strip- VBE

Birleştirme Şeridi- VBE

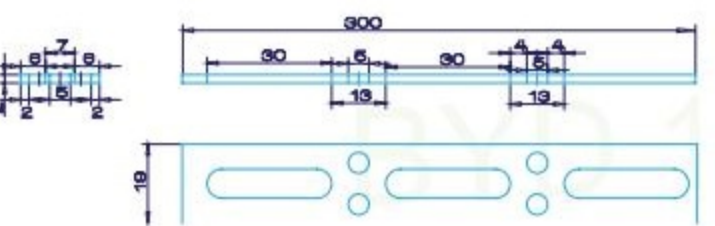

Straight connection 45 degree, 90 degree, Tee Bend connections Standard Connection Connection from the distance

Model Number	Size (W) (mm)	Plate Thick. (T) (mm)	Weight kg/m	In pack, pc	Order Code (PG)	Order Code (HDG)	Order Code (SS)
VBE 3	301	2	0,08	10	1805 02 030 20 1	1805 02 030 20 2	1805 02 030 20 4
VBE 6	602	2	0,12	10	1805 02 060 20 1	1805 02 060 20 2	1805 02 060 20 4
VBE 12	1204	2	0,24	10	1805 02 120 20 1	1805 02 120 20 2	1805 02 120 20 4

Connectors

Birleştirme Elemanları



Connector- TBE

Birleştirme Elemanı- TBE

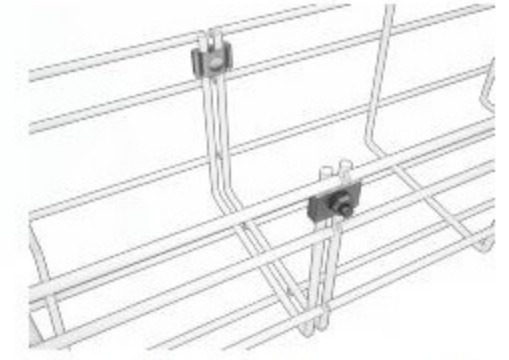

Model Number	Size (W) (mm)	Plate Thick. (T) (mm)	Weight kg/m	In pack, pc	Order Code (EG)	Order Code (HDG)	Order Code (SS)
U 30	30	2,5	1,15	100	1801 00 030 20 7	1801 00 030 20 2	1801 00 030 20 4
U 25	25	2,5	1,41	200	1802 00 020 20 7	1802 00 020 20 2	1802 00 020 20 4
C M6	M6x20		1,3	250	9005 06 020 00 7	9005 06 020 00 2	9005 06 020 00 4
FS M6	M6		1,45	500	9002 06 000 00 7	9002 06 000 00 2	9002 06 000 00 4

Calculation of connectors

Width (W)	H	
	35mm/60mm	85mm/110mm
50	2	
100	2	2+1
150	2	2+1
200	2+1	2+2
250	2+1	2+2
300	2+2	2+3
400	2+2	2+3
500	2+2	2+3
600	2+2	2+3

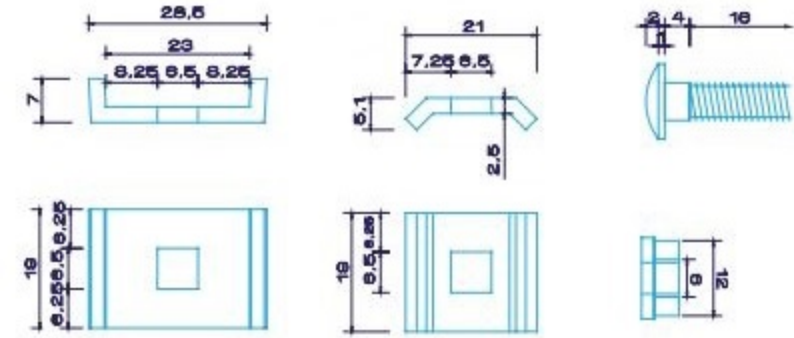

Reduction Side Connector- TKR

Redüksiyon Birleştirme Şeridi- TKR

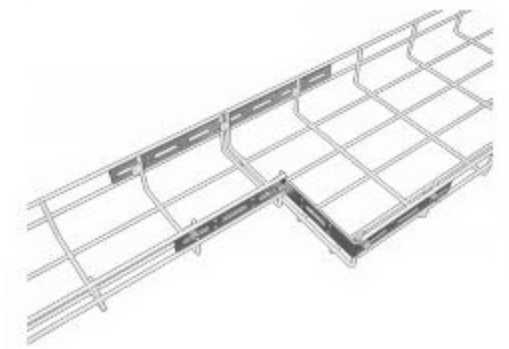

Connectors

Birleştirme Elemanları



Model Number	Size (W) (mm)	Plate Thick. (T) (mm)	Weight kg/m	In pack, pc	Order Code (PG)	Order Code (HDG)	Order Code (SS)
TKR 50	300	2	0,06	10	1806 00 050 20 1	1806 00 050 20 2	1806 00 050 20 4
TKR 100	350	2	0,07	10	1806 00 100 20 1	1806 00 100 20 2	1806 00 100 20 4
TKR 150	400	2	0,08	10	1806 00 150 20 1	1806 00 150 20 2	1806 00 150 20 4
TKR 200	450	2	0,09	10	1806 00 200 20 1	1806 00 200 20 2	1806 00 200 20 4
TKR 250	500	2	0,1	10	1806 00 250 20 1	1806 00 250 20 2	1806 00 250 20 4
TKR 300	550	2	0,11	10	1806 00 300 20 1	1806 00 300 20 2	1806 00 300 20 4

Used for reduction of trays

Used with TSE fixing unit

Supplied straight, easy bend by hand

Connectors

Boltless Quick Connector- HBE

Birleştirme Elemanları

Hızlı Birleştirme Elemanı- HBE



KT 430



Model Number	Size (W) (mm)	Plate Thick. (T) (mm)	Weight kg/m	In pack, pc	Order Code (PG)	Order Code (HDG)	Order Code (SS)
HBE	220 x18	1,2	0,09	100	1803 05 220 12 1	1803 05 220 12 2	1803 05 220 12 4

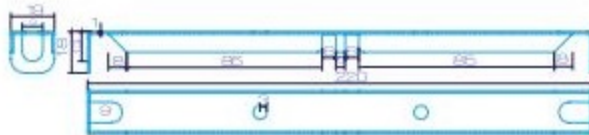

Width (W)	Pcs / Length
50	2
100	2
150	2
200	2
250	3
300	3
400	3
500	3
600	3

Used for connection of straight units height: 60mm, 85mm, 110 mm

Number of connectors are depend on tray sizes, see table of calculation