

Support

Hanger / Side Support

Destek Sistemi

Taşıyıcı / Yandan Aski Elemanı

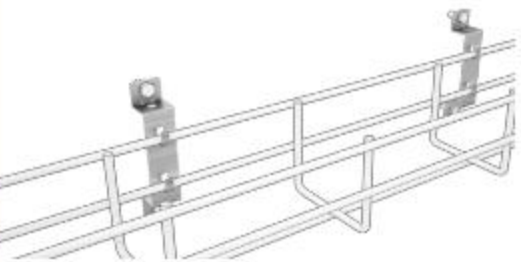

Used for wall support (side mounting)

| Model Number | Size (W) (mm) | Plate Thick. (T) (mm) | Weight kg/m | In pack, pc | Order Code (PG) | Order Code (HDG) | Order Code (SS) |
|--------------|---------------|-----------------------|-------------|-------------|------------------|------------------|------------------|
| HC | 113x30x30 | 1,5 | 5 | 100 | 1811 00 000 15 1 | 1811 00 000 15 2 | 1811 00 000 15 4 |

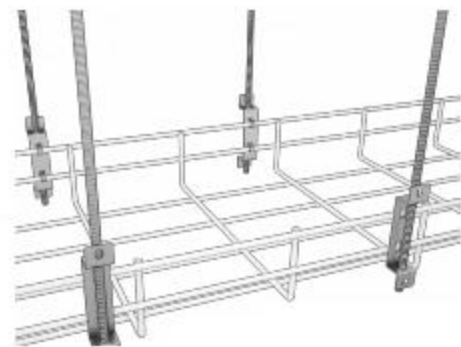
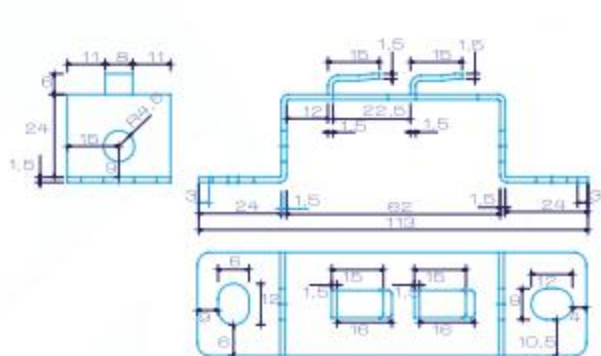

Used for threaded rod ceiling (side hanging)

Support

50 Floor Stand & Wall Bracket

Destek Sistemi

50 Kanal Destek (Yere ve Duvara Montaj Elemanı)



Used for wall & floor support

only used with 50x60mm trays

| Model Number | Size (W) (mm) | Plate Thick. (T) (mm) | Weight kg/m | In pack, pc | Order Code (PG) | Order Code (HDG) | Order Code (SS) |
|--------------|---------------|-----------------------|-------------|-------------|------------------|------------------|------------------|
| FWS 50 | 70x70 | 2 | 0,08 | 10 | 1815 00 000 20 1 | 1815 00 000 20 2 | 1815 00 000 20 4 |

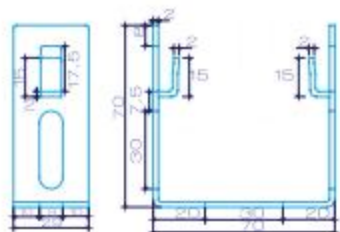

323

Support

Suspension Clamp / Central Support

Destek Sistemi

Ortadan Tek Tiji Taşıyıcı / Konsola Sabitleme Elemanı

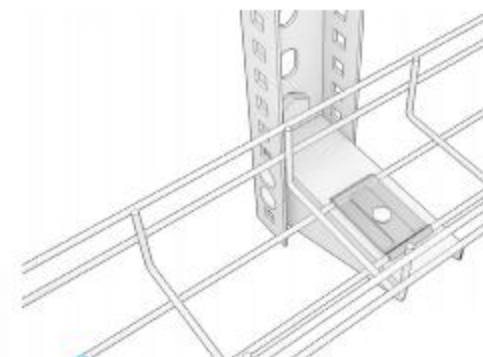
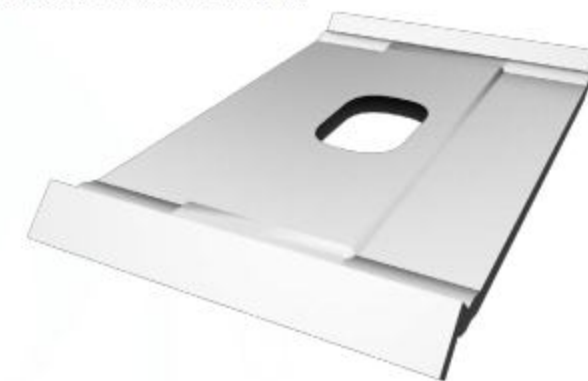

Used for fixing of tray to bracket:
One clamp required

| Model Number | Size (W) (mm) | Plate Thick. (T) (mm) | Weight kg/m | In pack, pc | Order Code (EG) | Order Code (HDG) | Order Code (SS) |
|--------------|---------------|-----------------------|-------------|-------------|------------------|------------------|------------------|
| SC | 60x35 | 2 | 1,5 | 50 | 1812 00 000 20 1 | 1812 00 000 20 2 | 1812 00 000 15 4 |

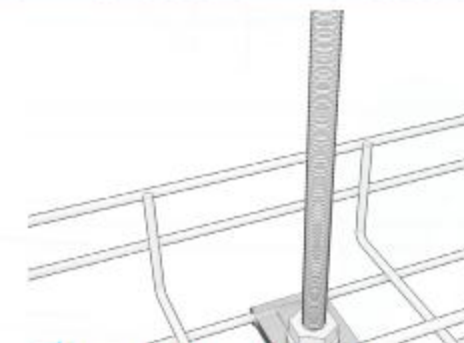
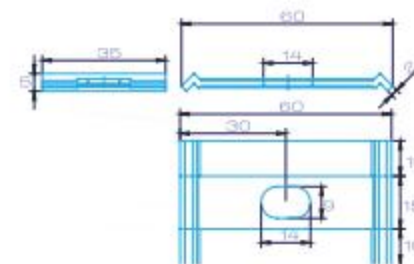

Used for fixing of tray to bracket:
Two clamps required for mounting

50 Ceiling Support

50 Kanal Destek Aski Aparatı

Support

Destek Sistemi

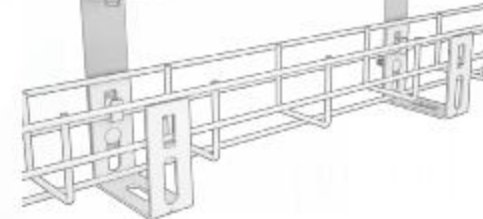
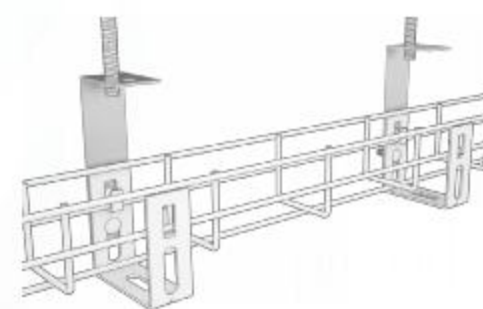

Used for wall & floor support

only used with 50x60mm trays

| Model Number | Size (W) (mm) | Plate Thick. (T) (mm) | Weight kg/m | In pack, pc | Order Code (PG) | Order Code (HDG) | Order Code (SS) |
|--------------|---------------|-----------------------|-------------|-------------|------------------|------------------|------------------|
| CS 50 | 110x45 | 2 | 0,05 | 10 | 1816 00 000 20 1 | 1816 00 000 20 2 | 1816 00 000 20 4 |

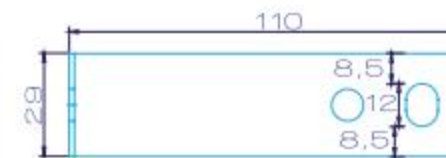
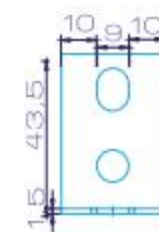

324

Wire Mesh Cable Trays

metakson

metakson

Wire Mesh Cable Trays

Support

Hanger / Central Support

Support For Floor and Wall Mounting

Support

Destek Sistemi

Tijli Aski Elemanı

Yere Duvara Tespit Elemanı (Tirnaklı)

Destek Sistemi

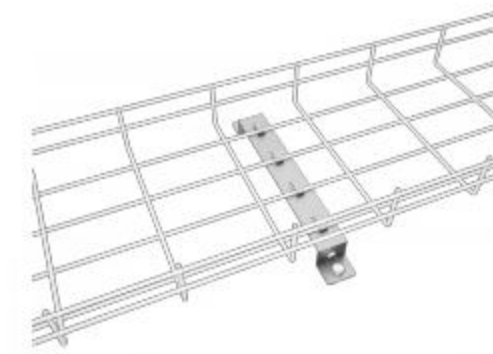
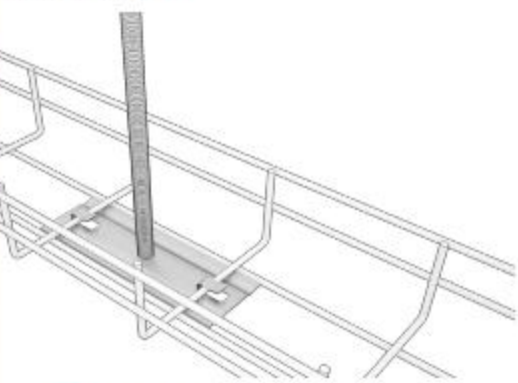

Used for threaded rod hanging

| Model Number | Size (W) (mm) | Plate Thick. (T) (mm) | Weight kg/m | In pack, pc | Order Code (PG) | Order Code (HDG) | Order Code (SS) |
|--------------|---------------|-----------------------|-------------|-------------|------------------|------------------|------------------|
| H 10 | 130X45 | 1,20 | 0,062 | 10 | 1820 20 100 12 1 | 1820 20 100 12 2 | 1820 20 100 12 4 |

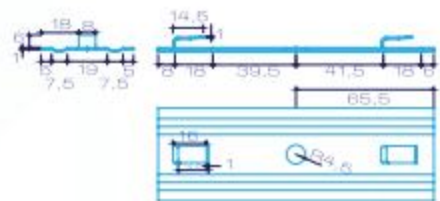

Used for wall support

Used for fixing of distribution boxes or illumination

Support

Hanging Rail / Support

Support For Wall Mounting

Support

Destek Sistemi

Çift Tijli Kanal Taşıyıcı (Tirnaklı)

Tirnaklı Duvar Konsol

Destek Sistemi

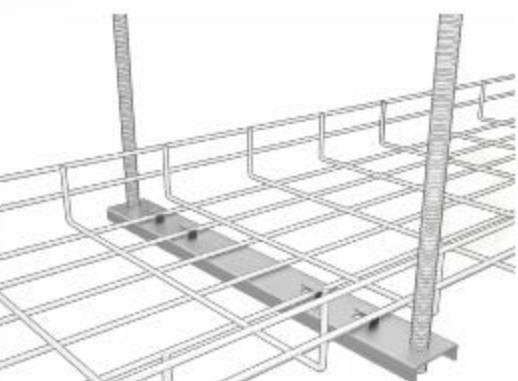

| Model Number | Size (W) (mm) | Plate Thick. (T) (mm) | Weight kg/m | In pack, pc | Order Code (PG) | Order Code (HDG) | Order Code (SS) |
|--------------|---------------|-----------------------|-------------|-------------|------------------|------------------|------------------|
| HR 15 | 150 | 1,50 | 0,141 | 210 | 1821 20 150 15 1 | 1821 20 150 15 2 | 1821 20 150 15 4 |
| HR 20 | 200 | 1,50 | 0,175 | 280 | 1821 20 200 15 1 | 1821 20 200 15 2 | 1821 20 200 15 4 |
| HR 25 | 250 | 1,50 | 0,208 | 310 | 1821 20 250 15 1 | 1821 20 250 15 2 | 1821 20 250 15 4 |
| HR 30 | 300 | 1,50 | 0,242 | 380 | 1821 20 300 15 1 | 1821 20 300 15 2 | 1821 20 300 15 4 |
| HR 40 | 400 | 1,50 | 0,309 | 480 | 1821 20 400 15 1 | 1821 20 400 15 2 | 1821 20 400 15 4 |
| HR 50 | 500 | 1,50 | 0,376 | 580 | 1821 20 500 15 1 | 1821 20 500 15 2 | 1821 20 500 15 4 |
| HR 60 | 600 | 1,50 | 0,443 | 680 | 1821 20 600 15 1 | 1821 20 600 15 2 | 1821 20 600 15 4 |

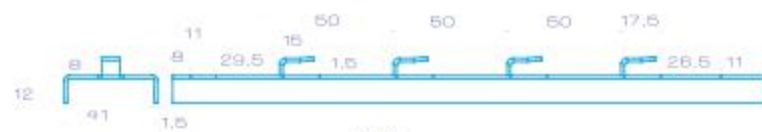

325

| Model Number | Size (W) (mm) | Plate Thick. (T) (mm) | Weight kg/m | In pack, pc | Order Code (PG) | Order Code (HDG) | Order Code (SS) |
|--------------|---------------|-----------------------|-------------|-------------|------------------|------------------|------------------|
| WBH 10 | 100 | 1,20 | 0,100 | 130 | 1823 00 100 12 1 | 1823 00 100 12 2 | 1823 00 100 12 4 |
| WBH 15 | 150 | 1,50 | 0,194 | 180 | 1823 00 150 15 1 | 1823 00 150 15 2 | 1823 00 150 15 4 |
| WBH 20 | 200 | 1,50 | 0,233 | 230 | 1823 00 200 15 1 | 1823 00 200 15 2 | 1823 00 200 15 4 |
| WBH 25 | 250 | 1,50 | 0,260 | 280 | 1823 00 250 15 1 | 1823 00 250 15 2 | 1823 00 250 15 4 |
| WBH 30 | 300 | 2,00 | 0,370 | 330 | 1823 00 300 15 1 | 1823 00 300 15 2 | 1823 00 300 15 4 |
| WBH 40 | 400 | 2,00 | 0,570 | 430 | 1823 00 400 15 1 | 1823 00 400 15 2 | 1823 00 400 15 4 |
| WBH 50 | 500 | 2,00 | 0,710 | 530 | 1823 00 500 15 1 | 1823 00 500 15 2 | 1823 00 500 15 4 |
| WBH 60 | 600 | 2,00 | 0,850 | 630 | 1823 00 600 15 1 | 1823 00 600 15 2 | 1823 00 600 15 4 |

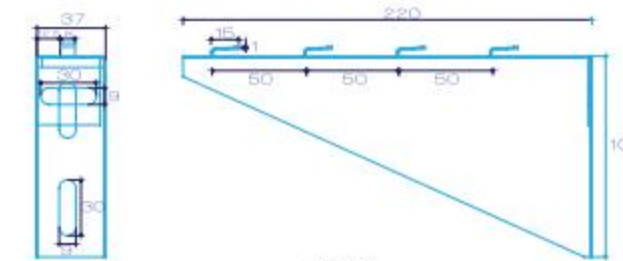

326

Support

Z Support for Floor and Wall Mounting

Destek Sistemi

Z Tipi Yere Duvara Tespit Elemanı (Tirnaklı)

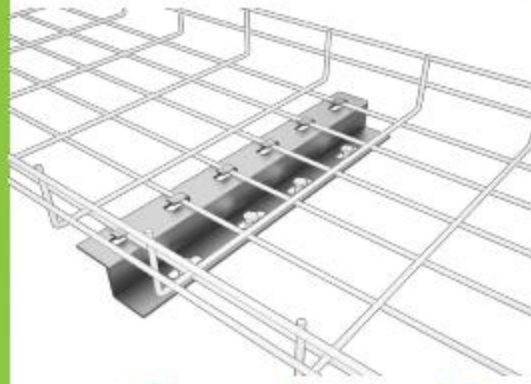

Model Number



Size (W) (mm)



Plate Thick. (T) (mm)



Weight kg/m



In pack, pc



Order Code (PG)



Order Code (HDG)



Order Code (SS)

| Model Number | Size (W) (mm) | Plate Thick. (T) (mm) | Weight kg/m | In pack, pc | Order Code (PG) | Order Code (HDG) | Order Code (SS) |
|--------------|---------------|-----------------------|-------------|-------------|------------------|------------------|------------------|
| ZFW 10 | 100 | 1,50 | 0,110 | 30 | 1824 00 100 15 1 | 1824 00 100 15 2 | 1824 00 100 15 4 |
| ZFW 15 | 150 | 1,50 | 0,160 | 30 | 1824 00 150 15 1 | 1824 00 150 15 2 | 1824 00 150 15 4 |
| ZFW 20 | 200 | 1,50 | 0,210 | 30 | 1824 00 200 15 1 | 1824 00 200 15 2 | 1824 00 200 15 4 |
| ZFW 25 | 250 | 1,50 | 0,260 | 30 | 1824 00 250 15 1 | 1824 00 250 15 2 | 1824 00 250 15 4 |
| ZFW 30 | 300 | 2,00 | 0,420 | 30 | 1824 00 300 15 1 | 1824 00 300 15 2 | 1824 00 300 15 4 |
| ZFW 40 | 400 | 2,00 | 0,570 | 30 | 1824 00 400 15 1 | 1824 00 400 15 2 | 1824 00 400 15 4 |
| ZFW 50 | 500 | 2,00 | 0,710 | 30 | 1824 00 500 15 1 | 1824 00 500 15 2 | 1824 00 500 15 4 |
| ZFW 60 | 600 | 2,00 | 0,850 | 30 | 1824 00 600 15 1 | 1824 00 600 15 2 | 1824 00 600 15 4 |

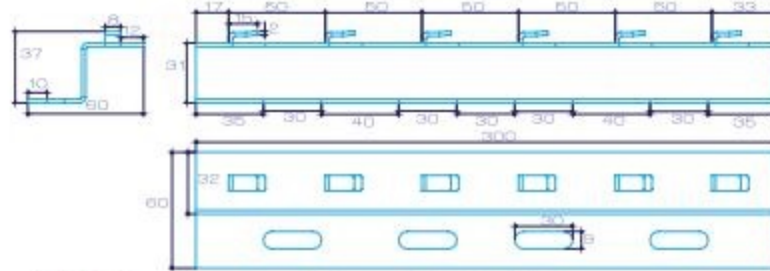

Support

Wall Bracket and Box Mount Plate

Destek Sistemi

Duvar Konsolu ve Kutu Sabitleme Elemanı

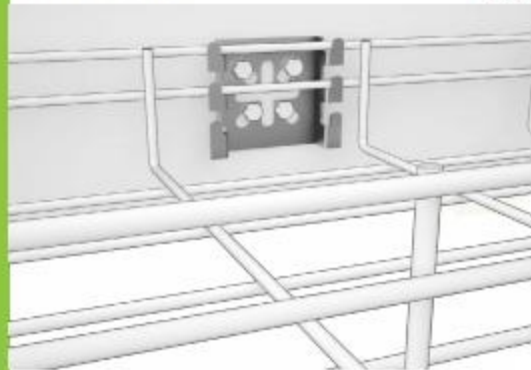

Model Number



Size (W) (mm)



Plate Thick. (T) (mm)



Weight kg/m



In pack, pc



Order Code (PG)



Order Code (HDG)



Order Code (SS)

| Model Number | Size (W) (mm) | Plate Thick. (T) (mm) | Weight kg/m | In pack, pc | Order Code (PG) | Order Code (HDG) | Order Code (SS) |
|--------------|---------------|-----------------------|-------------|-------------|------------------|------------------|------------------|
| MSB | 85*75 | 2,00 | 0,1 | 50 | 1817 75 085 20 1 | 1817 75 085 20 2 | 1817 75 085 20 4 |

Used for threaded rod hanging

Used for wall support

Used for fixing of distribution boxes or illumination

